

Smart
connections.

Operating manual

PIKO 36 EPC

Legal notice

KOSTAL Solar Electric GmbH
Hanferstraße 6
79108 Freiburg i. Br.
Germany
Phone +49 (0)761 477 44 - 100
Fax +49 (0)761 477 44 - 111
www.kostal-solar-electric.com

Exclusion of liability

All names, trademarks, product names or other designations used in this manual may be legally protected even if not indicated as such (e.g. as a trademark). KOSTAL Solar Electric GmbH assumes no liability or warranty for their free usage. The illustrations and texts have been compiled with great care. However, the possibility of errors cannot be ruled out. The compilation is made without any guarantee.

General note on gender equality

KOSTAL Solar Electric GmbH is aware of the importance of language with regard to the equality of women and men and always makes an effort to reflect this in the documentation. Nevertheless, for the sake of readability we are unable to use non-gender-specific terms throughout and use the masculine form instead.

© 2017 KOSTAL Solar Electric GmbH

All rights reserved by KOSTAL Solar Electric GmbH, including those of reproduction by photocopy and storage in electronic media. Commercial use or distribution of the texts, displayed models, diagrams and photographs appearing in this product, is not permitted. This manual may not be reproduced, stored, transmitted or translated in any form or by means of any medium, in whole or in part, without prior written permission.

Software version as of FW: 05.55
User Interface (UI) as of: 06.30

Contents

1. General information	6
1.1 Proper use	8
1.2 EU declarations of conformity	10
1.3 About this manual	11
1.4 Notes in this manual	13
1.5 Symbols used	17
1.6 Labels on the inverter	18
2. Device and system description	19
2.1 The photovoltaic system	20
2.2 Inverter components	21
3. Installation	29
3.1 Transport and storage	30
3.2 Scope of delivery	31
3.3 Installation	32
3.4 Electrical connection	35
3.5 Central system protection	38
3.6 Installing overvoltage protection (optional)	40
3.7 Connection of solar module	44
3.8 Connection of communication components	48
3.9 Initial commissioning	52
4. Operation and operating the device	54
4.1 Switching on the inverter	55
4.2 Switching off the inverter	56
4.3 De-energising the inverter	57
4.4 Control panel	58
4.5 Operational status (display)	61
4.6 Operational status (LEDs)	62
4.7 The menu structure of the inverter	63
4.8 The service menu	67
4.9 The energy management system in the inverter	68
4.10 Event codes	69

5.	Webserver	76
5.1	The Webserver	77
5.2	Using the Webserver	78
5.3	Connecting the inverter and computer	79
5.4	Calling up Webserver	80
5.5	Disconnecting the inverter from the computer	81
5.6	Menu structure in Webserver	82
5.7	Webserver main menu	84
5.8	Webserver submenus	85
6.	System monitoring	93
6.1	Creating connection between computer and inverter	94
6.2	The log data	97
6.3	Retrieving, saving and graphically depicting log data	100
7.	Active power control	103
7.1	Why active power control?	104
7.2	Limitation of the PV feed-in capacity	105
7.3	Active power control with a ripple control receiver	106
7.4	Installing the ripple control receiver	107
8.	Maintenance	110
8.1	Maintenance and service	111
8.2	Fan cleaning	112
8.3	Update software (communication board)	116
8.4	Update software (inverter firmware)	118
8.5	Update software (country settings)	120
8.6	Replacing optional overvoltage protection	122
9.	Technical data	126
9.1	Technical data	127
9.2	Block diagram	132

10. Accessories	133
10.1 Additional accessories	134
11. Appendix	137
11.1 Type plate	138
11.2 Warranty and service	139
11.3 Handover to the operator	140
11.4 Disassembly and disposal	141
Index	142

1. General information

1.1	Proper use	8
1.2	EU declarations of conformity	10
1.3	About this manual	11
1.4	Notes in this manual	13
1.5	Symbols used	17
1.6	Labels on the inverter	18

Thank you for choosing a PIKO inverter from KOSTAL Solar Electric GmbH! We hope you enjoy consistently high energy yields with the PIKO inverter and your photovoltaic system.

If you have any technical questions, please call our service hotline:

- Germany and other countries¹
+49 (0)761 477 44 - 222
- Switzerland
+41 32 5800 225
- France, Belgium, Luxembourg
+33 16138 4117
- Greece
+30 2310 477 555
- Italy
+39 011 97 82 420
- Spain, Portugal²
+34 961 824 927
- Turkey³
+90 212 803 06 26

¹ Language: German, English

² Language: Spanish, English

³ Language: English, Turkish

1.1 Proper use

The PIKO inverter converts direct current into alternating current. This can be used as follows:

- For self-consumption
- For feed-in into the public grid

The device may only be used in grid-connected photovoltaic systems within the permissible power range and under the permissible ambient conditions. The device is not intended for mobile use.

Inappropriate use may lead to injury or even death for the user or third parties. Material damage to the device and other equipment can also occur. The inverter may therefore only be used for its intended purpose.

All components fitted on the inverter or in the PV system must satisfy the standards and guidelines that apply in the country of installation.

Exclusion of liability

Any use that differs from that described in **Ch. 1.1** or goes beyond the stated intended purpose, is considered inappropriate. The manufacturer accepts no liability for any damage resulting from this. Modifications to the inverter are prohibited. The inverter may only be used if it is safe to operate and is in a technically perfect condition. Any instance of misuse will result in the termination of the warranty, guarantee and general liability of the manufacturer.

Only a qualified electrician may open the device. The inverter must be installed by a trained electrician (according to DIN VDE 1000-10 or BGV A3 accident prevention regulations) who is responsible for observing the applicable standards and regulations.

Work that could affect the electrical power system of the relevant energy supply company at the site of the solar power feed-in, may only be carried out by qualified electricians expressly authorised (licensed) by the energy supply company. This includes changes to the factory-preset parameters. The installer must always observe the regulations of the energy supply company.

Factory settings may only be changed by qualified electrical installers or persons with at least comparable or higher technical qualifications, e.g. foremen, technicians or engineers. When doing so, all requirements are to be observed.



IMPORTANT INFORMATION

The inverter may only be installed, maintained and repaired by a trained and qualified electrician.

The electrician is responsible for ensuring that the applicable standards and regulations are observed and implemented. Work that could affect the electrical power system of the relevant energy supply company at the site of the solar power feed-in, may only be carried out by qualified electricians expressly authorised (licensed) by the energy supply company.

This includes changes to the factory-preset parameters.

1.2 EU declarations of conformity

KOSTAL Solar Electric GmbH hereby declares that the inverter described in this document complies with the basic requirements and other relevant conditions of the directives listed below.

- Directive 2014/30/EU
(on the approximation of the laws of the Member States relating to electromagnetic compatibility (EMC))
- Directive 2014/35/EU
(on the harmonisation of the laws of the Member States relating to the making available on the market of electrical equipment designed for use within certain voltage limits – in short: Low Voltage Directive)
- Directive 2011/65/EU (RoHS)
to limit the use of certain hazardous substances in electrical and electronic equipment

You will find a detailed EU Declaration of Conformity at:

www.kostal-solar-electric.com/Download/Zertifikate

1.3 About this manual

Carefully read this manual in full. 

It contains important information on the installation and operation of the inverter. Pay particular attention to the instructions regarding safe usage. KOSTAL Solar Electric GmbH assumes no liability for damages arising from the non-observance of this manual.

This manual is an integral part of the product. It applies exclusively to the PIKO inverters from KOSTAL Solar Electric GmbH. Keep this manual and give it to the new owner should you pass it onto a new operator.

The installer and the operator must have unrestricted access to these instructions at all times. The installer must be familiar with this manual and follow all instructions.

The most recent version of the operating manual for your product is available in the download area at www.kostal-solar-electric.com.

Target group

This manual is intended for trained and qualified electrical technicians who install, maintain and repair the inverters.

The inverters described in this manual differ from one another in terms of particular technical details. Information and handling instructions that only apply to certain device types, are to be identified accordingly.

Information concerning your safety or that of the unit is specifically noted.



TIP

Print both sides on one sheet of paper when printing out this operating manual.

This saves paper and the document remains easy to read.

Navigation through the document

In order to enable navigation through this document, it contains clickable areas.

One of these is the navigation bar in the header of each page. Here you can go to the overview pages of the individual chapters in one click.

The table of contents can also be used in this way: From the index at the beginning of each chapter you can go to the indicated sub-chapter in one click.

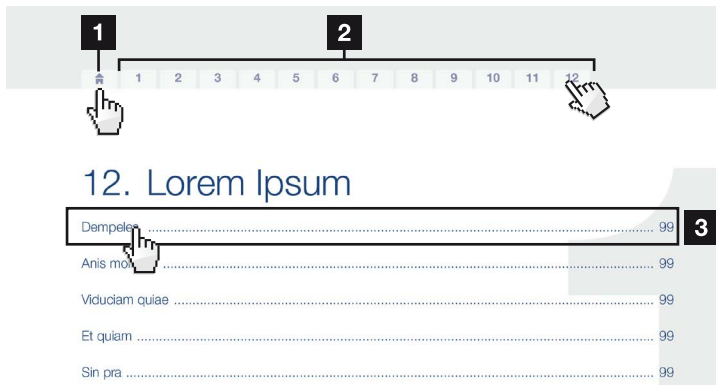

Fig. 1: Navigation through the document

- 1** Calling up the main table of contents
- 2** Navigation bar
- 3** Tables of contents

You can navigate to the referenced points in the document within the instruction text using the cross-references.

- 🔗 Ch. 1**
- 🔗 Fig. 1, It. 2**

Fig. 2: Examples of cross-references

1.4 Notes in this manual

Installation ⚠️

Installing the wall mount and hanging the inverter

- Mark the positions of the drill holes at the installation site by using the wall mount as a drilling template.
- Drill holes and insert wall anchors if necessary.
- Screw the wall mount to the intended surface.
- Use the supplied screws.

Connecting AC-side ⚠️

We recommend a mains cable with the cross-section $3 \times 2.5 \text{ mm}^2$. The outer diameter of the cable can be 9...17 mm, the cross-section of the individual conductors can be a max. of 4 mm^2 for flexible cables and a max. of 6 mm^2 for rigid cables. For flexible cables, we recommend using core end sleeves.

Remove the sheath and the insulation of the mains cable as much as needed.

First thread the unscrewed union nut and then the sealing ring over the cable. ⓘ

2 **DANGER**

Risk of death due to electrical shock
Always disconnect the device from the power supply during installation and before maintenance and repairs and lock it to prevent it being switched back on.

3 **IMPORTANT NOTE**

Press the blind plug and the sealing ring out of the screw connection from the inside outwards using a screwdriver or similar implement.

4 **NOTE**

To connect the AC and DC cables, the inverter is equipped with spring-loaded terminal strips.

Fig. 3: Safety instructions in this manual

- 1** Reference icon within the instruction text
- 2** Warning
- 3** Information note
- 4** Other notes

Notes have been incorporated into the instruction text. A differentiation is made in this manual between warnings and information notes. All notes are identified in the text line with an icon.

Warnings

The warnings refer to life-threatening dangers. Serious injuries may occur which result in death.

Each warning consists of the following elements:

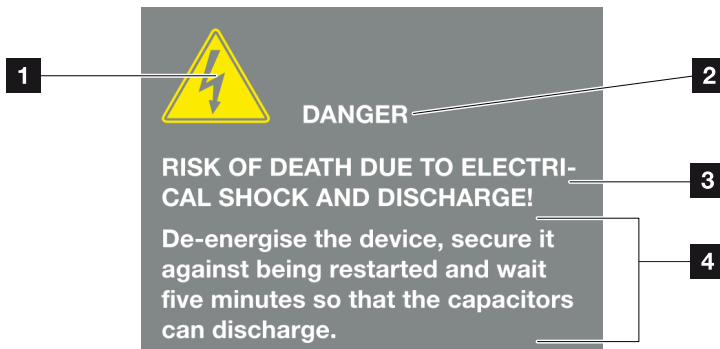

Fig. 4: Structure of the warnings

- 1** Warning symbol
- 2** Signal word
- 3** Type of danger
- 4** Corrective actions

Warning symbols



Danger



Danger due to electrical shock and discharge



Danger due to electromagnetic fields



Danger due to burns

Signal words

Signal words are used to identify the severity of the danger.

DANGER

Indicates a direct hazard with a high level of risk, which, when it is not avoided, may result in death or serious injury.

WARNING

Indicates a hazard with a moderate level of risk, which, when it is not avoided, may result in death or serious injury.

CAUTION

Indicates a hazard with a low level of risk, which, when it is not avoided, may result in minor or slight injury or property damage.

Information notes

Information notes contain important instructions for the installation and problem-free operation of the inverter. These must be followed at all times. The information notes also point out that failure to observe can result in damage to property or financial damages.

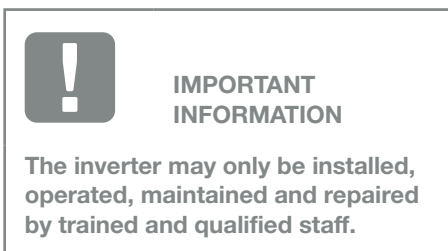

Fig. 5: Example of an information note

Symbols within the information notes



Important information



Damage to property possible

Other notes

They contain additional information or tips.



INFO

This is additional information.

Fig. 6: Example of an information note

Symbols within the additional notes



Information or tip



Enlarged view

1.5 Symbols used

Symbol	Meaning
1., 2., 3. ...	Sequential steps in a handling instruction
→	Effect of a handling instruction
✓	Final result of a handling instruction
☞	Cross-reference to other places in the document or to other documents
■	List

Tab. 1: Symbols and icons used

Abbreviations used

Abbreviation	Explanation
Tab.	Table
Fig.	Figure
It.	Item
Ch.	Chapter

1.6 Labels on the inverter

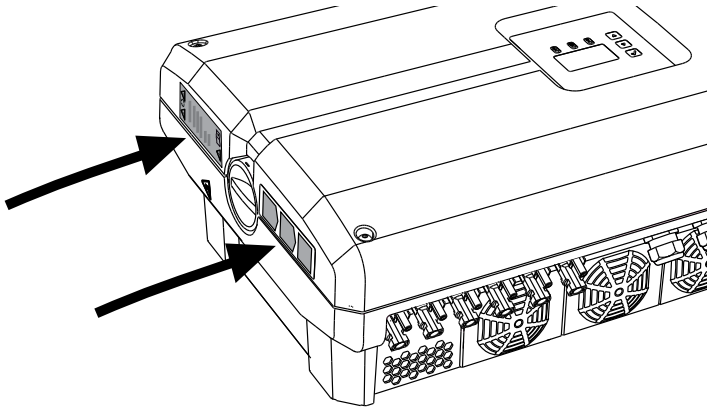







Fig. 7: Labels on the inverter – Figure example

Signs and labels are applied to the housing of the inverter. These signs and labels may not be altered or removed.

Symbol	Explanation
	Danger due to electrical shock and discharge
	Danger due to electrical shock and discharge. Wait five minutes (discharge time of the capacitors) after shut-down
	Danger due to burns
	Danger notice

Symbol	Explanation
	Additional earth connection
	Observe and read operating manual
	Device may not be disposed of with household waste. Observe the local application disposal requirements
	CE marking The product satisfies the applicable EU requirements

2. Device and system description

2.1 The photovoltaic system	20
2.2 Inverter components	21



2.1 The photovoltaic system

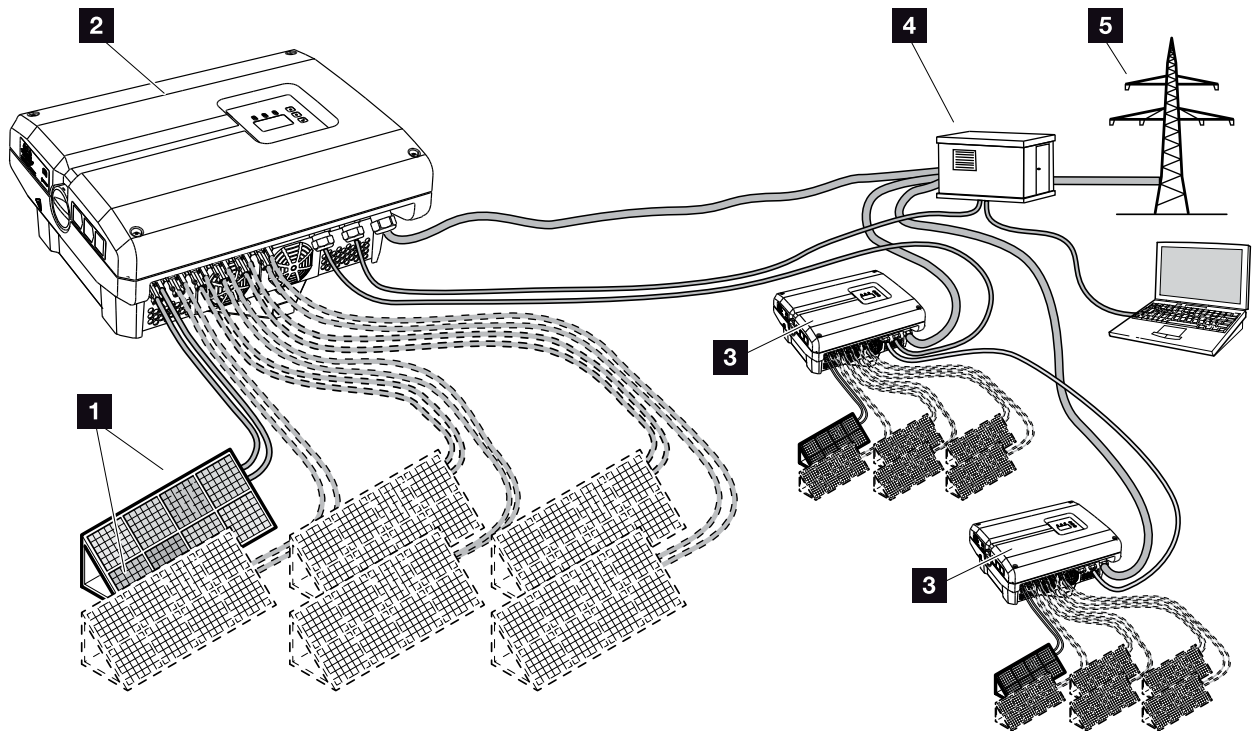

Fig. 8: Photovoltaic system

- 1 PV string (2-6 optional)
- 2 Inverter
- 3 Further inverters with PV strings
- 4 Distributor
- 5 Public grid

2.2 Inverter components

Exterior view of the inverter

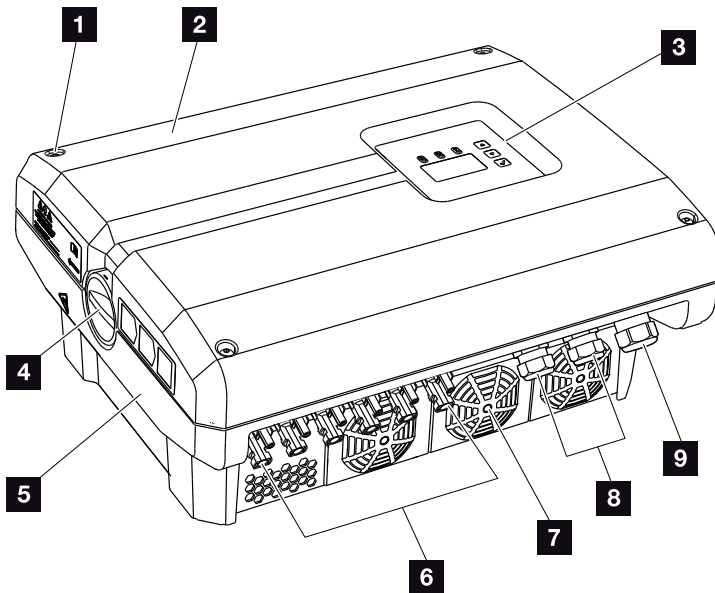

Fig. 9: PIKO inverter (exterior view)

- 1** Cover screws
- 2** Cover
- 3** Display
- 4** DC switch
- 5** Housing
- 6** Plug connectors for connecting the solar modules
- 7** Fan
- 8** Cable openings for optional communication
- 9** Opening for the mains cable

DC switch on the inverter

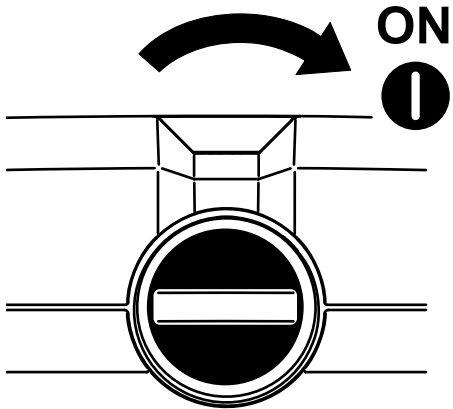

Fig. 10: DC switch ON

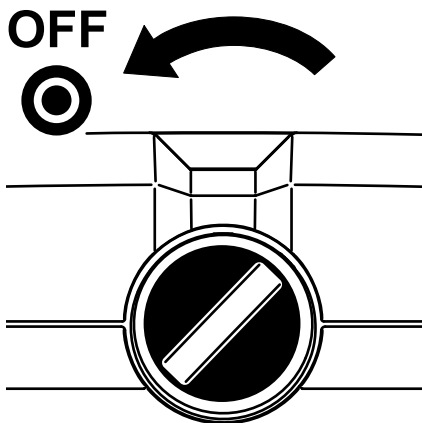

Fig. 11: DC switch OFF

Interior view of the inverter

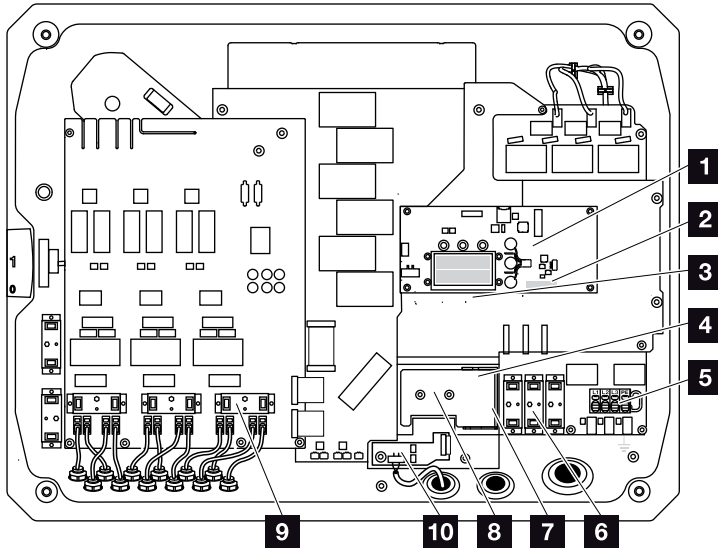

Fig. 12: PIKO inverter (interior view)

- 1** Communication board
- 2** Terminal for analog interface and RS485
- 3** Ethernet connections (RJ45)
- 4** Cable tray with fastening openings
- 5** AC terminal
- 6** Receptacle for overvoltage protection on AC side (optional)
- 7** Installation position for RS485 overvoltage protection (optional)
- 8** Installation position for LAN overvoltage protection (optional)
- 9** Receptacle for overvoltage protection on DC side (optional)
- 10** Grid and system protection provided by a PIKO EPC AC Off Switch card

The communication board

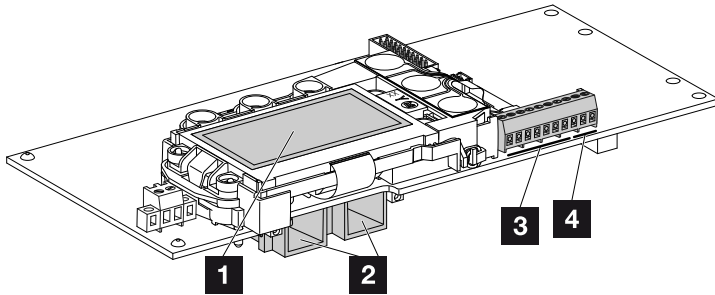

Fig. 13: Components of the communication board

- 1 Display
- 2 2 Ethernet connections (RJ45)
- 3 Analog interface terminal
- 4 RS485 terminal

The communication board is the communications centre of the inverter. The connections for communication, the display and the control buttons are located on the communication board.

The control panel

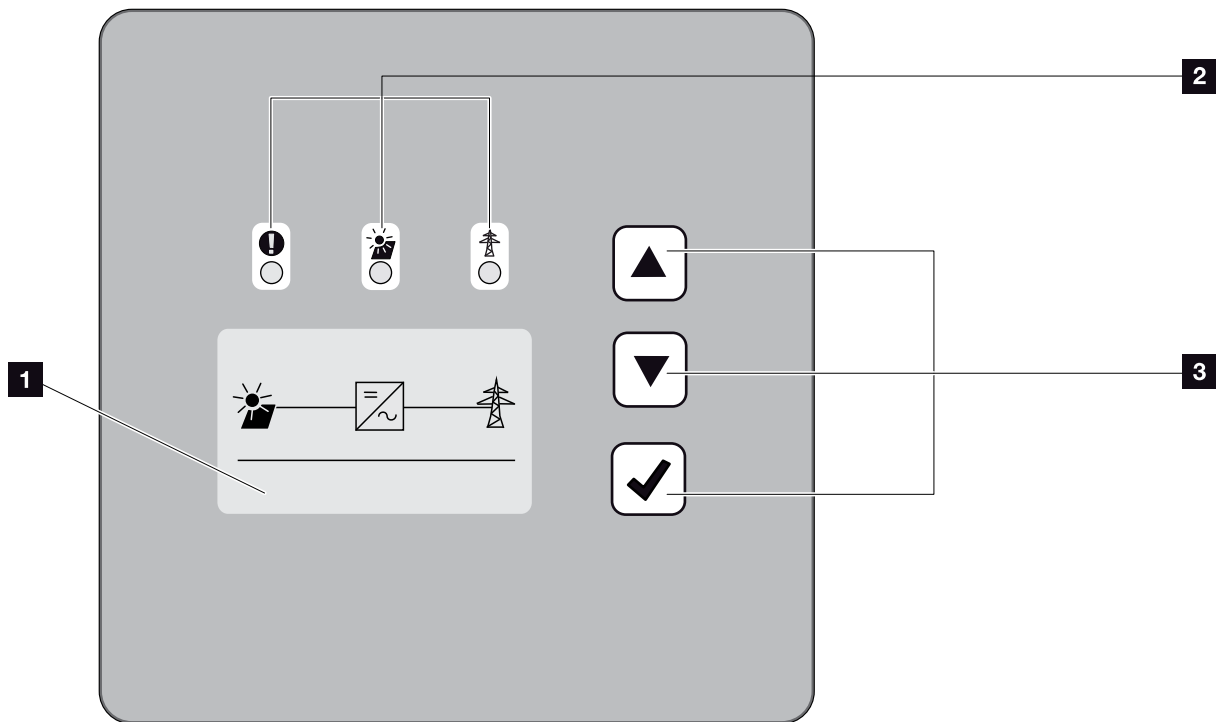

Fig. 14: Control panel

- 1** Display (display dependent upon the inverter type)
- 2** LEDs for displaying the operational status
- 3** Control buttons

Adjustments can be made and data retrieved via the control panel. Event messages are shown on the display.

The main menu

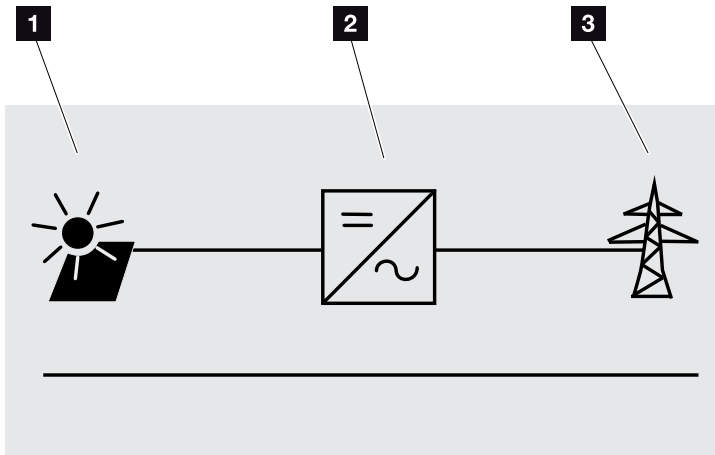



Fig. 15: Main menu

- 1 "DC" menu
- 2 "Settings" menu
- 3 "AC" menu

The Webserver

The Webserver is a graphic interface (representation in the browser) for the retrieval and configuration of the inverters. It offers the following content:

 **Ch. 5.1**

Webserver pages	Function
Home	Displays inverter status and current yield values
Current values	Displays the current values of the PV generators, grid connection, analog interfaces and the use of the S0/AL-Out terminal on the communication board.
Statistics	Displays yield and consumption for day or total and log data.
Settings	Inverter configuration
Info	Displays all inverter events and versions (e.g. user interface, firmware, hardware). You can also view these versions without logging into the Webserver.
Login/Logout	Login: Page for logging into Webserver. You can log in as a plant owner or as an installer.  Logout: Menu item to log out of the Webserver.



INFO

You need a service code to log in as an installer. This can be obtained from the Service team.

 **Ch. 11.2**

Tab. 2: Overview of the Webserver pages

The data logger

A data logger is integrated in the PIKO inverter. The data logger is a data storage system for the yield and performance data of the inverter and the storage system. Yield data (saving interval) can be saved every 5, 15 or 60 minutes. The data logger is set in the factory to a saving interval of 15 minutes. The saving interval can be changed at the "Settings" Webserver page. 

Saving interval	Saving time
5 minutes	Max. 130 days
15 minutes	Max. 400 days
60 minutes	Max. 1500 days

Tab. 3: Saving intervals of data logger



INFO

Pay attention to the memory storage time when selecting the saving interval!

When the internal memory is full, the oldest data will be overwritten. For long-term backup, the data must be backed up with a PC or sent to a solar portal.

3. Installation

3.1	Transport and storage	30
3.2	Scope of delivery	31
3.3	Installation	32
3.4	Electrical connection	35
3.5	Central system protection	38
3.6	Installing overvoltage protection (optional)	40
3.7	Connection of solar module	44
3.8	Connection of communication components	48
3.9	Initial commissioning	52

3.1 Transport and storage

The function of the inverter has been tested and it has been carefully packaged prior to delivery. Upon receipt, check the delivery for completeness and any transport damage. 📦

Complaints and damage claims are to be directly addressed to the shipping company.

If stored for a longer period before installation, all inverter components must be kept dry and dust-free in the original packaging.

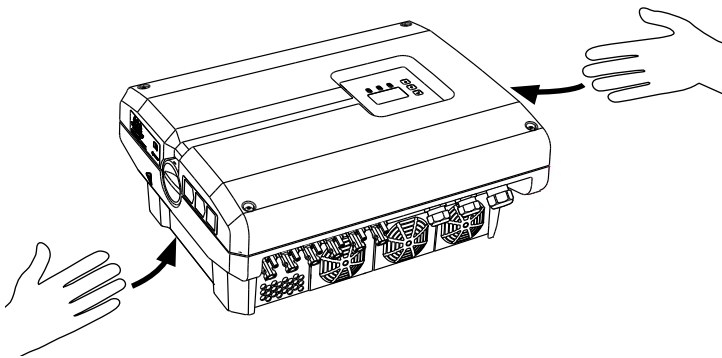

Fig. 16: Recessed grips on inverter

Recessed grips have been integrated to the left and right for better transport of the inverter.



DAMAGE POSSIBLE

Given its size and weight, the inverter's packaging is only intended for shipping by pallet.

Risk of damage when the inverter is placed on its underside. Always place the inverter on its rear side (cooling elements) after unpacking.

3.2 Scope of delivery

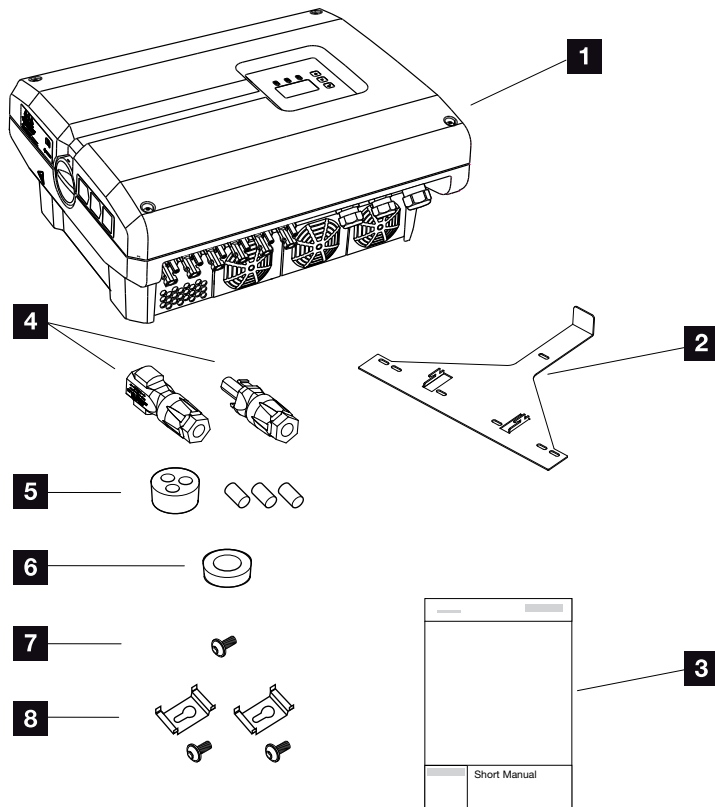

Fig. 17: Scope of delivery

The packaging contains:

- 1** 1 x inverter
- 2** 1 x wall mount (not for replacement devices)
- 3** 1 x short manual
- 4** DC plug connector
(each DC input: 1× plug, 1× socket)
- 5** Plug seals for screw connection of network cable
- 6** Reducing ring for screw connection of AC cable with a diameter of 15-23 mm
- 7** 1 x M4×9 lock screw for inverter
- 8** 2 x LAN overvoltage protection brackets with M4x9 screws

3.3 Installation

Selecting the installation site

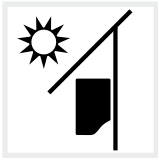

Protect inverter against exposure to direct sunlight.



Protect inverter from rain and splash water.



Protect inverter from falling parts which could enter the inverter's ventilation openings. 

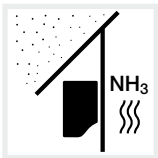

Protect the inverter against dust, contamination and ammonia gases. Rooms and areas containing livestock are not permitted as installation sites.

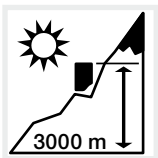

Inverter may only be installed up to an altitude of 3000 m. (Derating as of 2000 m)



The ambient temperature must be between -25 °C and +60 °C.

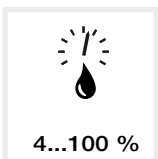

The air humidity must be between 4 % and 100 % (condensing).

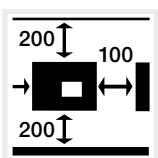

Maintain minimum distances to other inverters and the necessary clearance.



IMPORTANT INFORMATION

Observe these instructions when selecting the installation site. Guarantee claims may be restricted or become entirely null and void in the event of failure to observe.

This device is classified as equipment class A. It may therefore cause radio interference in a domestic environment. If this occurs, the operator may be required to take appropriate measures.



DAMAGE POSSIBLE

Falling parts that enter the fan through the inverter's cooling ribs may block the fan. Insufficient cooling of the inverter may result in output reduction or the failure of the system.

To provide protection against falling parts, an optional accessory (cover plate) that covers the cooling ribs but still allows cooling, can be ordered from your service partner or a specialist shop.

There must be a free space of 320 mm above the inverter to fit the optional accessory.

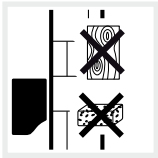

Mount inverter on a stable installation surface that can safely bear the weight. Plasterboard walls and wood planking are not permitted.



Mount inverter on a non-flammable installation surface. 

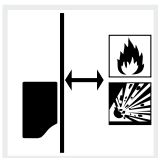

A sufficient safety distance from flammable materials and potentially explosive areas in the vicinity must be ensured.

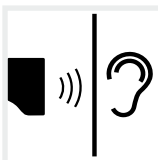

Inverters can cause noise when in operation. Install inverter in such a way that people are not disturbed by operation noises.

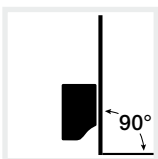

Mount inverters on vertical installation surfaces. For this purpose, use the wall mount provided.



Install inverters so that they are not accessible to children.

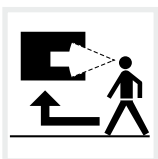

Inverters must be easily accessible and the display clearly visible.



WARNING

RISK OF BURNS FROM HOT PARTS ON THE INVERTER!

Some of the inverter components can reach temperatures of over 80 °C during operation. Select the installation site in accordance with the information provided in these instructions. Always keep the ventilation openings clear.

Wall mounting ! !

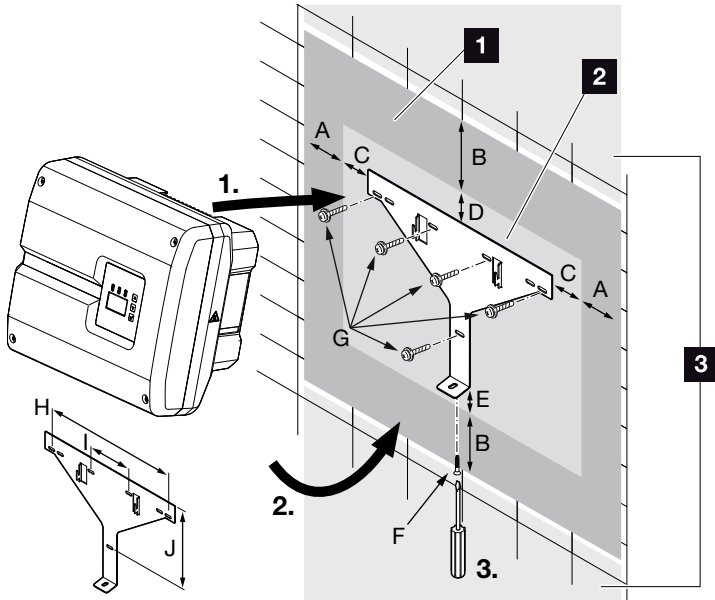

! IMPORTANT INFORMATION
 Be absolutely sure to maintain the clearance around the inverter in order that the inverter remains cool.

! IMPORTANT INFORMATION
 Only use the provided wall mount.
 To fit the wall mount, use 5 retaining bolts (not part of the scope of delivery).

Fig. 18: Wall mounting with wall mount

- 1** Clearance
- 2** Outer dimensions of the inverter
- 3** Inverters may not be installed in this area

You can find the distances for wall mounting in the following table:

Dimensions in mm (inch)						Screws	Wall mount		
A	B	C	D	E	F	G	H	I	J
100 (3.9)	200 (7.9)	76 (2.99)	46 (1.8)	2 (0.1)	M4 x 9	min. 6 (0.236 in) / 8.8	507 (20)	106 (4.2)	402 (15.8)

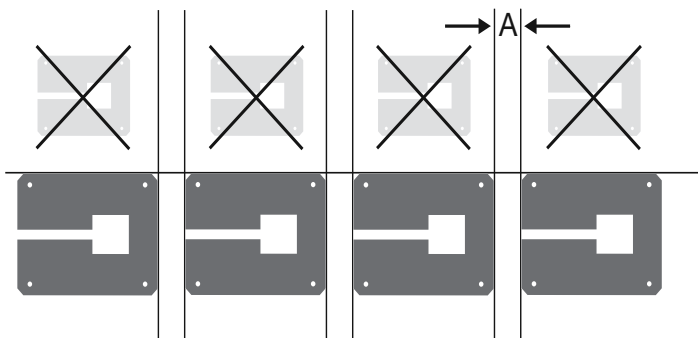

Fig. 19: Wall mounting of several inverters

3.4 Electrical connection

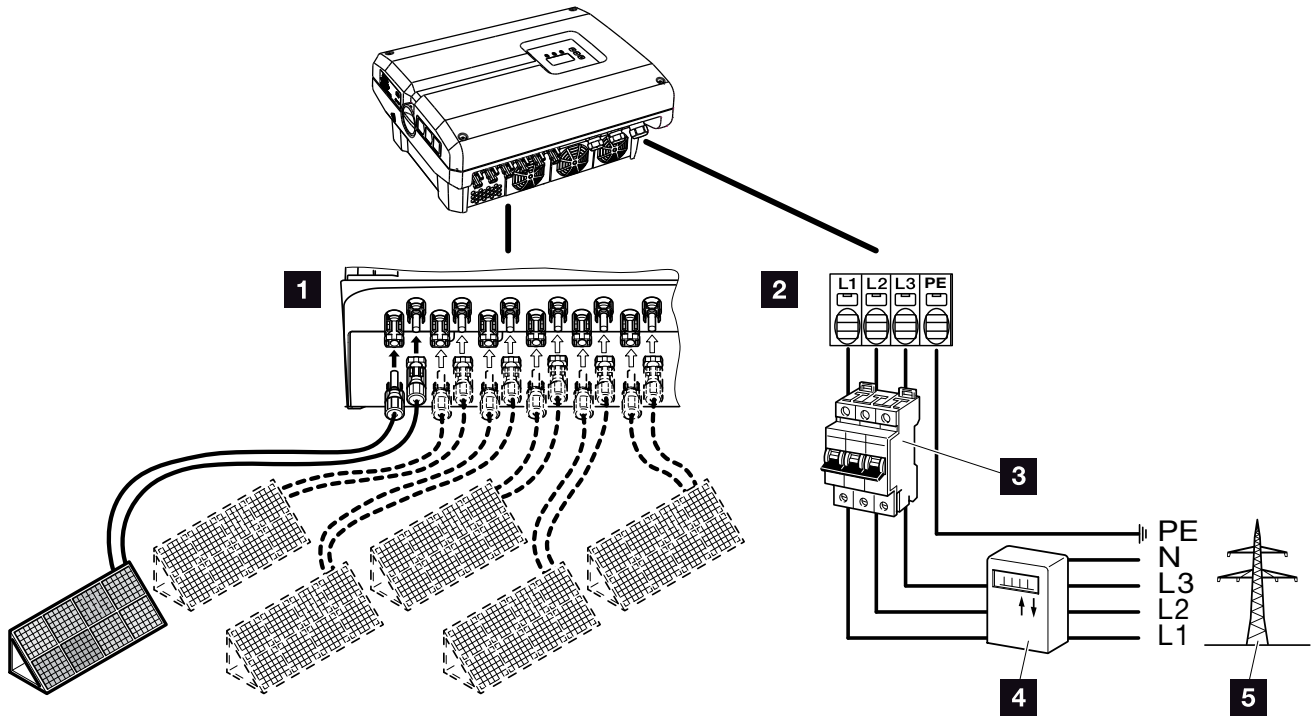

Fig. 20: Overview of electrical connections

Inverter connections

- 1 DC connections
- 2 AC terminal !

External connections !

- 3 Line circuit breaker for inverter
- 4 Electricity meter
- 5 Public grid



IMPORTANT INFORMATION

It must be ensured that the phases of the AC terminal and the consumers are assigned uniformly.



IMPORTANT INFORMATION

This product may generate a direct current in the outer protective earthing conductor. If protective residual current devices (RCD) or residual current monitoring devices (RCM) are used, only type B ≥ 300 mA RCDs or RCMs are permitted on the AC side. Refer to the manufacturer's declaration on our website for exceptions.

Connecting mains cable

1. De-energise the inverter.
🔧 **Ch. 4.3**
2. Switch off DC switch on the inverter.
🔧 **Fig. 11**
3. Secure it against reactivation.
4. Correctly lay the mains cable from the power distributor to the inverter. ⚠️

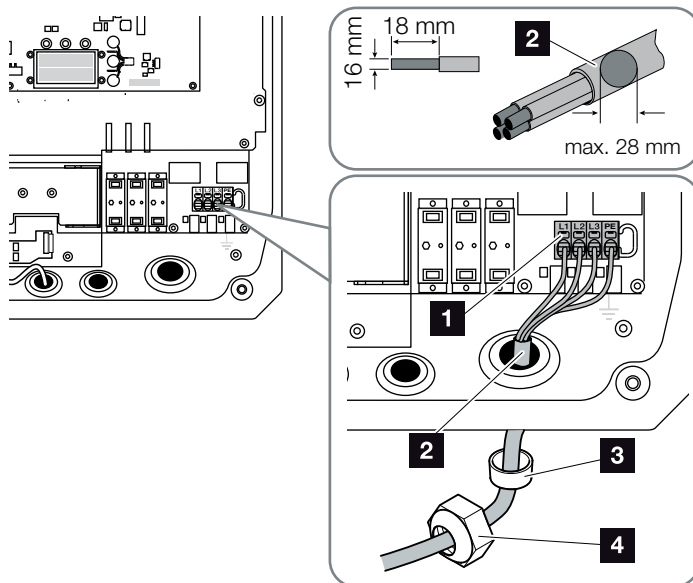

Fig. 21: Connect mains cable to the inverter

- 1 AC terminal
 - 2 Mains cable
 - 3 Sealing ring
 - 4 Union nut
5. Insert mains cable into the inverter and seal with sealing ring and union nut. Tighten union nut to the prescribed torque. Torques: 13 Nm (M40). ⚠️
 6. If screw connections are not being used, leave the blind plug in the screw connections.



IMPORTANT INFORMATION

See the "Technical Data" chapter for the dimensioning of the required AC line circuit breaker and the cable cross-section and cable type to be used. 🔧 Ch. 9.1

If using an AC cable with an outer diameter of 15-23 mm, the reducing ring provided should be used.

Both single-wire (type NYY-J) and multi-wire (type NYM-J) cables without core end sleeves can be used with the AC terminal.

When using cables with fine wires (type H05../H07RN-F), core end sleeves should be used. Ensure that there is a contact surface of 18 mm.



IMPORTANT INFORMATION

Existing cables and their routing within the inverter must not be changed. This can otherwise result in malfunctions in the inverter.

7. Connect the wires of the mains cable to the AC terminal in accordance with the labelling. 

 Fig. 21, Pos. 1

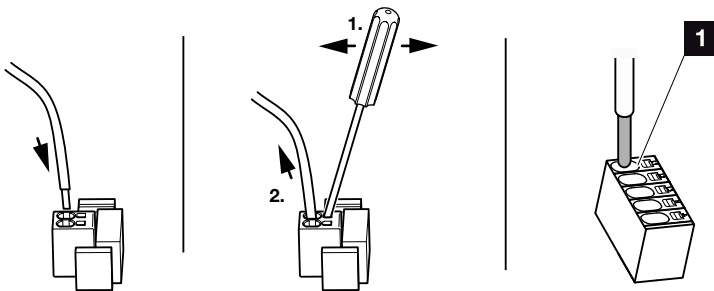





Fig. 22: Spring-loaded terminal strip

8. Install a line circuit breaker into the mains cable between the inverter and the feed meter to secure it against overcurrent. 
9. In countries in which a second PE connection is prescribed, connect this at the marked place on the housing (inside or outside) with the prescribed torque of 3 Nm (M6).  Fig. 23, It. 1 

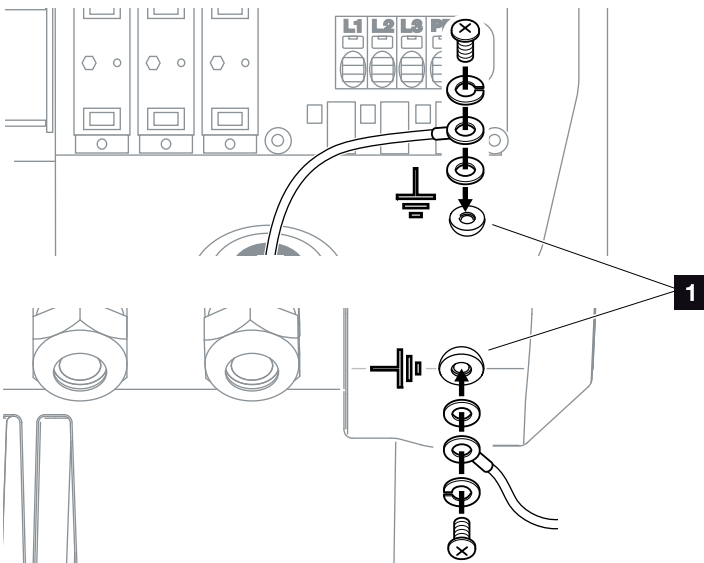

Fig. 23: Country-specific PE connection, inside / outside

- ✓ The AC connection is connected.



IMPORTANT INFORMATION

To connect the AC cables, the inverter is equipped with spring-loaded terminal strips. The wires should be inserted into the large round openings (It. 1) of the terminal. The wire stripping length is 18mm.



WARNING

RISK OF FIRE DUE TO OVERCURRENT AND HEATING OF THE MAINS CABLE!

Install line circuit breaker to secure against overcurrent.



IMPORTANT INFORMATION

The dimensioning of the cable cross-section to be used and the cable type must match the local requirements.

See "Technical data" chapter  Ch. 9.1

3.5 Central system protection

Central grid and system protection is required in some countries. This monitors the voltage and frequency in the grid and in the event of a fault, shuts down the photovoltaic systems by means of a circuit breaker. Check the requirements of your energy provider to find out whether central grid and system protection is needed for your system.

If external grid and system protection is used, the **PIKO EPC AC Off Switch** board in the inverter can be used as the switching element, which provides the function of a circuit breaker in conjunction with the inverter's certified grid and system protection function. **i**

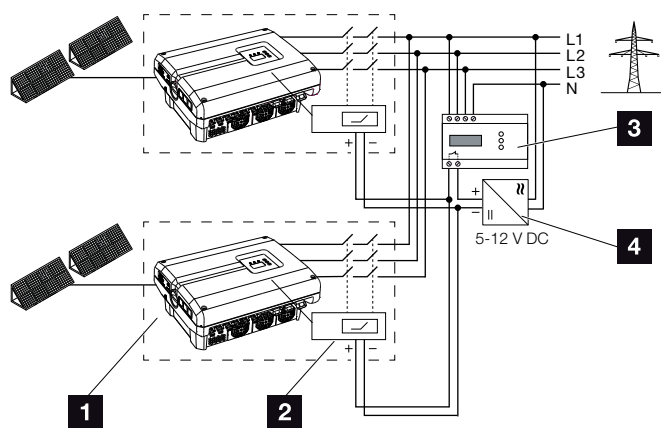

Fig. 24: Circuit breaker function

- 1** Inverter with internal printed circuit board (PCB)
- 2** PIKO EPC AC Off Switch printed circuit board (PCB)
- 3** External grid and system protection for monitoring unit
- 4** External voltage supply

Thanks to the smart controller of the PIKO EPC AC Off Switch board, which is activated by the external monitoring unit, the PIKO inverter switches off immediately as soon as the monitoring unit opens the contact and the external voltage supply is thereby shut down.



INFO

The «PIKO EPC AC Off Switch» board needs an external voltage supply (5-12 V DC), which has to be provided by the external voltage supply.

In the event of an error, this voltage is switched off by the external monitoring unit and the PIKO inverter is disconnected from the grid.

The external voltage supply for the PIKO EPC AC Off Switch board should be operated at 12 V DC in order to ensure a safe function even with longer cable lengths.

Connecting control cable with external sensor

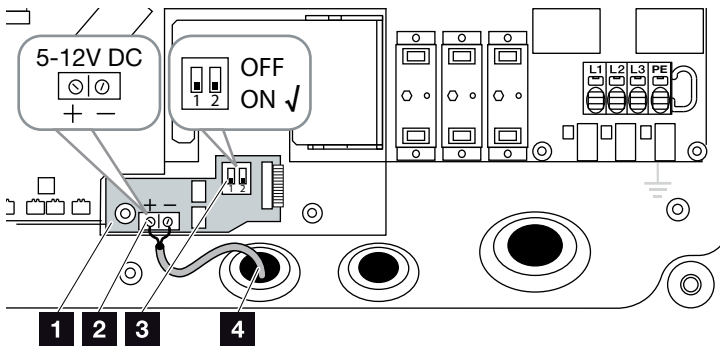



Fig. 25: PIKO EPC AC Off Switch board

- 1** PIKO EPC AC Off Switch board
 - 2** Terminal for control line (5-12 V DC)
 - 3** ON/OFF function switch
 - 4** Control cable for external monitoring unit
- 1.** Guide control cable into inverter and connect to terminal  **Fig. 25, It. 2** of printed circuit board (PCB).
 - 2.** Connect control cable with external sensor.
 - 3.** Move DIP switch to ON position  **Fig. 25, It. 3**
- ✓ Grid and system protection connected

3.6 Installing overvoltage protection (optional)

When supplied, the inverter does not have overvoltage protection.

In order to protect the inverter from overvoltage damage, type 2 overvoltage protection can be used on the AC and DC sides.

Modules can be inserted on the communication board's retaining plate to provide the communication cables with overvoltage protection.

The overvoltage protection modules can be obtained from your service partner, specialist shops or the KOSTAL Solar Electric GmbH online shop. The types which can be used are listed on the following pages in the Info block.

If overvoltage protection has been inserted in the inverter, recurring or disproportionately high overvoltages may result in accelerated wear and failure of the overvoltage protection used. The function of the overvoltage protection used on the AC and DC sides is therefore monitored by the inverter electronics. The inverter signals the failure of one or more overvoltage protection components with a corresponding event code. 



INFO

The function of the overvoltage protection modules of the communication cables cannot be monitored by the inverter electronics.

Problems in communication with the inverter indicate failure of the overvoltage protection modules. If this happens, the modules should be checked.

Inserting AC/DC overvoltage protection

1. Insert overvoltage protection on the AC and/or DC side. **i**

The overvoltage protection is coded (by means of a pin on the base and module base) and cannot be inserted the other way round. Note the coding at the plug-in positions.

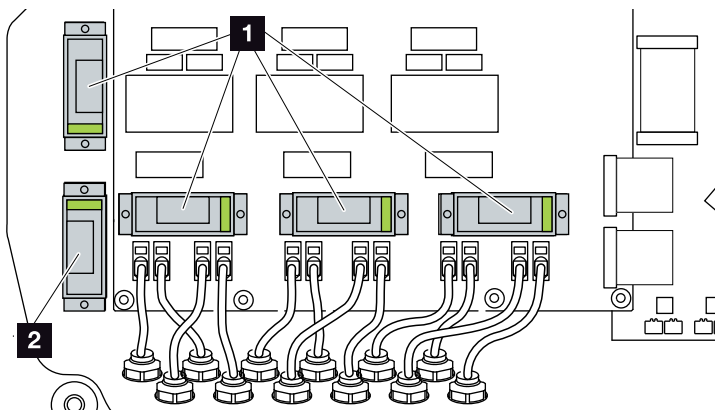

Fig. 26: Installation positions for DC overvoltage protection

- 1** Overvoltage protection for DC side 4 x
- 2** Overvoltage protection for DC side 1 x

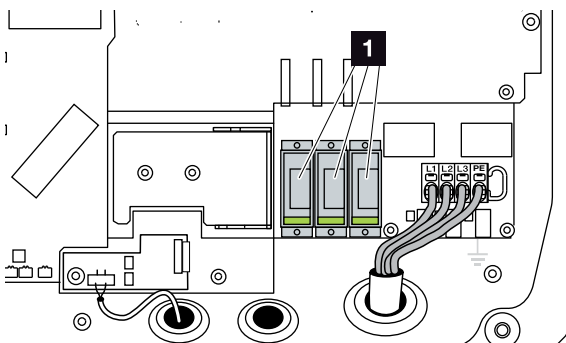

Fig. 27: Installation positions for AC overvoltage protection

- 1** Overvoltage protection for AC side 3 x
- ✓ Overvoltage protection installed



INFO

Note the manufacturer's installation and assembly instructions for the overvoltage protection.

The following types are approved for the overvoltage protection and can be ordered from the KOSTAL online shop:

DC side:
 4 x MOD PV SCI 600 DG (10334450)
 1 x MOD PV 600 (10334451)

AC side:
 3 x MOD 275 (10324116)

Inserting LAN overvoltage protection

1. Fit the mounts provided for LAN overvoltage protection on the inverter's retaining plate (5 Nm)

Fig. 28, It. 1. i

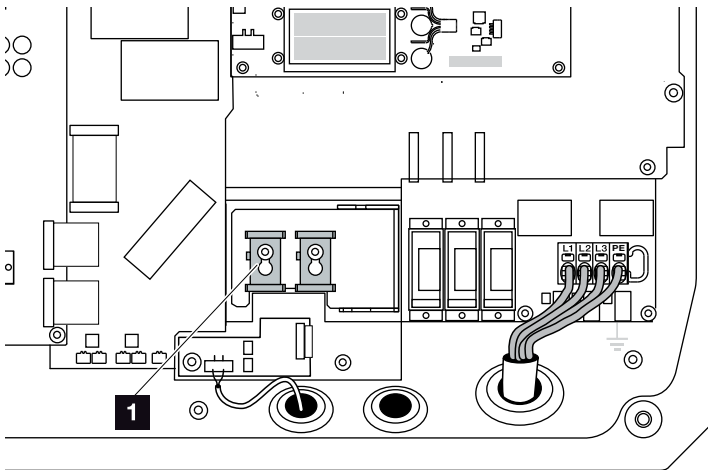

Fig. 28: LAN overvoltage protection mount

1. Overvoltage protection mount 2 x
2. Install overvoltage protection of communication cables for LAN. Insert the modules into the fitted mount. Plug the communication cables into the corresponding module and connect on to the communication board.

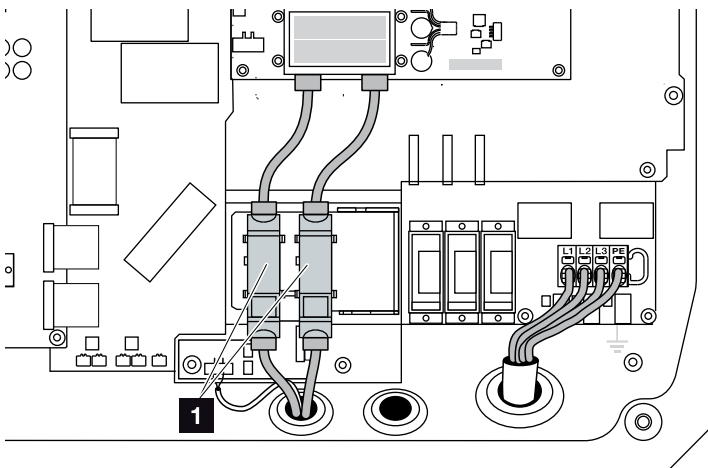

Fig. 29: LAN overvoltage protection

1. Installation position for overvoltage protection 2 x
- ✓ Overvoltage protection installed



INFO

Note the manufacturer's installation and assembly instructions for the overvoltage protection.

The following types are approved for the overvoltage protection and can be ordered from the KOSTAL online shop:

Ethernet connection (LAN):
2 x CLD RJ45B (10324083)

Inserting RS485 overvoltage protection

1. Install overvoltage protection of communication cables for RS485. Connect the module to the retaining plate intended for this purpose. The module is designed for fastening top-hat rails. Plug the communication cables into the module and connect on to the communication board. **i**

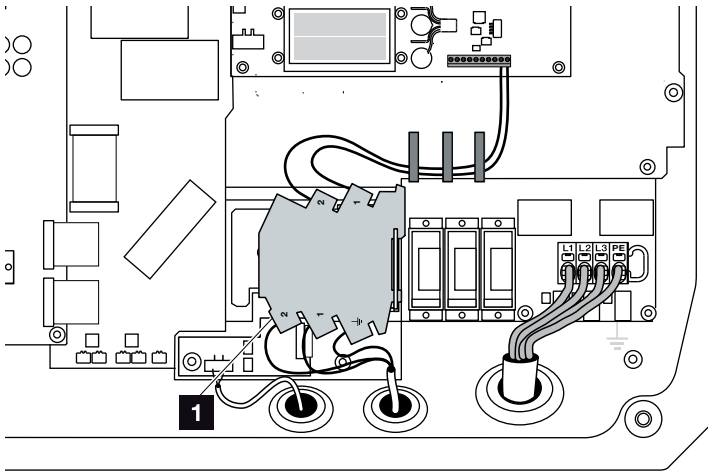

Fig. 30: RS485 overvoltage protection in the inverter

- 1** Installation position for overvoltage protection
RS485 connections 1 x
- ✓ Overvoltage protection installed



INFO

Note the manufacturer's installation and assembly instructions for the overvoltage protection.

The following types are approved for the overvoltage protection and can be ordered from the KOSTAL online shop:

RS485 connection:
1 x DCO SD2 ME (RS485) (10330764)

3.7 Connection of solar module

Solar module connections

Note the following before connecting the DC plugs:

- Check for the correct planning and wiring of the modules and then measure the DC idling voltage for plausibility.
- In order to ensure an optimal layout of the solar modules and the highest possible yields, the system should be designed within the voltage range between V_{MPPmin} and V_{MPPmax} . KOSTAL Solar Plan should be used as a planning tool here.
- If the output of the solar modules is higher than that specified in the technical data, it must be ensured that the working point is still within the MPP voltage range of the inverter.
- The types of solar module used, the number of solar modules and their orientation, should be the same for all PV strings. This avoids loss of earnings.
- The following DC inputs are connected in parallel internally in the inverter and are each shown as a string in the inverter menu and in the Webserver.

Display in inverter menu or Webserver	Internal wiring in the inverter
DC1	DC1 and DC2
DC2	DC3 and DC4
DC3	DC5 and DC6

- The connected power in the Technical Data always refers to one string. However, since two strings are always connected in parallel, the power (e.g. of DC1/DC2) may be split differently over the strings (e.g. 13/13 or even 20/6).



WARNING

RISK OF FIRE DUE TO IMPROPER INSTALLATION!

Incorrectly fitted plugs and sockets may heat up and cause a fire. During installation, be sure to follow the manufacturer's requirements and manual. Properly mount plugs and sockets.



WARNING

SERIOUS BURNS DUE TO ARCS ON THE DC SIDE!

DC cables must never be connected to or disconnected from the device during operation, as dangerous arcs may form. De-energise DC side, then mount or remove plug connector!



WARNING

INJURIES CAN RESULT FROM DESTRUCTION OF THE DEVICE!





When the maximum values for the permitted input voltage at the DC inputs are exceeded, this can result in serious damage, which may destroy the device and cause serious injury to any person present. Even briefly exceeding the voltage can cause damage to the device.

- If two PV strings are jointly connected to one DC input using a Y-splitter, these strings and the parallel string (e.g. DC1 and DC2) must also be protected using separate string fuses.
- Please ensure that the maximum permitted DC idling voltage is not exceeded.
Record and keep the measured values.
- Provide these measured values in the event of a complaint.

Failure to do so will make any manufacturer's warranty, guarantee or liability null and void unless you can prove that the damage was not due to non-compliance.

Connecting solar module

Only solar modules of the following category may be connected: Class A as specified in IEC 61730.

1. The PV strings may only be connected to the inverter when the housing is closed.
Install the cover and screw it tight (5 Nm). 
2. De-energise the inverter. 
 **Ch. 4.3**
3. If there is more than one inverter in a PV system, ensure that no cross-connection occurs when the PV generators are connected. 

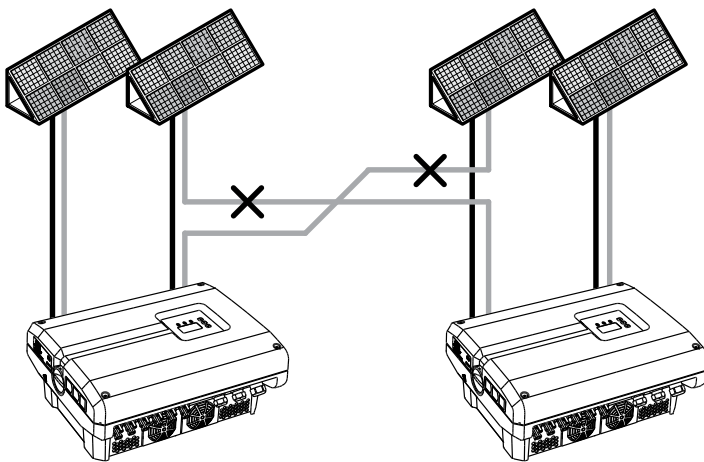

Fig. 31: Incorrect connection of PV generators

4. Check the strings for earth faults and short circuits and correct these where appropriate.



DANGER

RISK OF DEATH DUE TO ELECTRICAL SHOCK AND DISCHARGE!

The PV generators/cables may be live as soon as they are exposed to light.



IMPORTANT INFORMATION

If incorrectly assembled, the screws securing the cover may seize and destroy the thread inside the housing. Tighten the cover screws crosswise and do not fully tighten them immediately. This will make the cover more centred on the housing and prevent the screws inside the housing from seizing.



DANGER

RISK OF DEATH DUE TO ELECTRICAL SHOCK AND DISCHARGE!

De-energise the device, secure it against being restarted and wait five minutes so that the capacitors can discharge.  **Ch. 4.3**



DAMAGE POSSIBLE

If the PV generators are incorrectly connected, the inverter may be damaged. Check the connections before commissioning.

5. Correctly fit the plug on the positive cable and the socket on the negative cable. The inverter is equipped with plug connectors from PHOENIX CONTACT (type SUNCLIX). Be absolutely sure to take note of the manufacturer's latest information (e.g. use of tools, permitted torques, etc.)¹ when installing.
Pay attention to the correct polarity when mounting the sockets and the plugs on the DC cables of the solar modules! The poles of the PV strings (PV field) must not be earthed. **!**
6. Plug the sockets and plugs of the DC cables onto the inverter. Keep the plug seals from the plug connectors. **!**

¹Information about installation is available at www.phoenixcontact.com

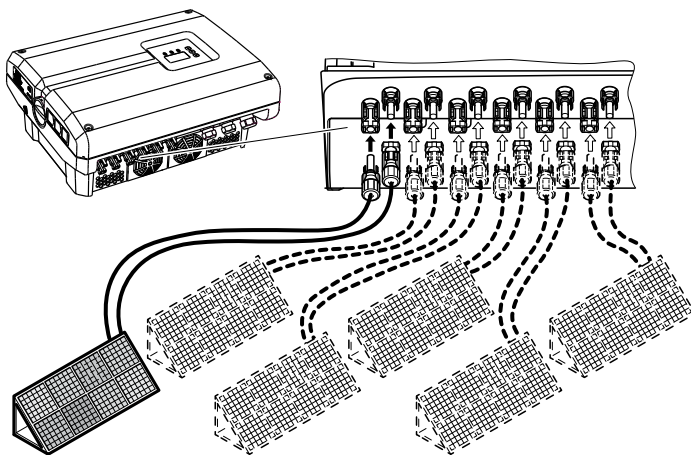

Fig. 32: Overview of DC connections

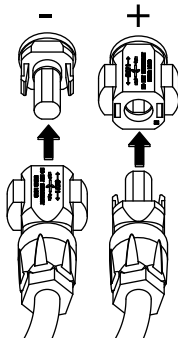

Fig. 33: Connect the PV string

✓ The DC side is connected.



IMPORTANT INFORMATION

The cross-section of the DC cables should be as large as possible, a maximum of 4 mm² for flexible cables and 6 mm² for rigid cables. We recommend using tin-plated cables. If non-tin-plated cables are used, the copper strands may oxidise, as a result of which the transition resistance of the connections will be too high.



IMPORTANT INFORMATION

The types of solar module used, the number of solar modules and their orientation, should be the same for all PV strings.
If two PV strings are jointly connected to one DC input (e.g. DC1) using a Y-splitter, these strings and the parallel string (e.g. DC1/DC2) must also be protected using separate string fuses.

3.8 Connection of communication components

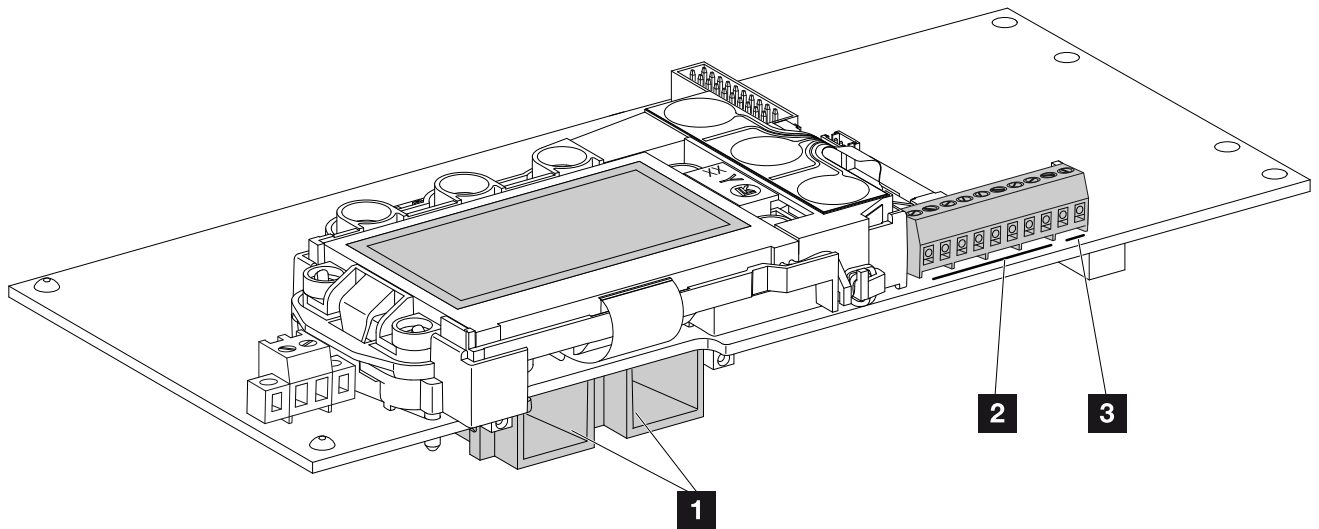

Fig. 34: Components of the communication board

- 1** 2 Ethernet connections (RJ45)
- 2** Analog interface terminal
- 3** Terminal for RS485 interface

The communication board is the communications centre of the inverter. The connections for communication, the display and the control buttons are located on the communication board.

Terminal (10-pin)

The 10-pin terminal is structured as follows.

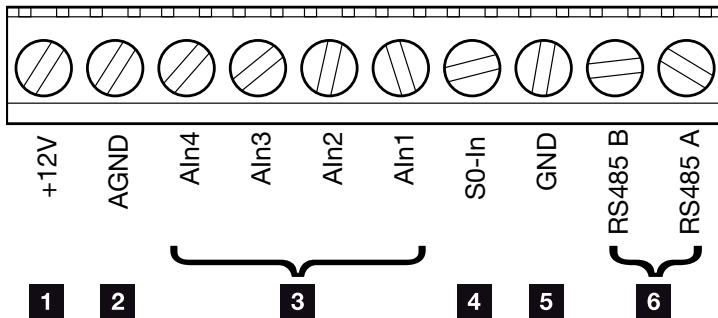

Fig. 35: Structure of the 10-pin terminal

Voltage output

- 1 +12V:** 12 V output for external sensors or for ripple control receivers. **i**

Analog inputs

- 2 AGND:** Ground for analog inputs and S0 input
- 3 Ain4-1:** Inputs for analog sensors (0–10 V) or for ripple control receivers. **i**

Pulse meter input

- 4 S0-In:** The S0 input registers the pulses of an energy meter. **i**

RS485 connections

- 5 GND:** Ground for RS485
- 6 RS485 connections A & B:** Serial RS485 interfaces for the connection of external data loggers, energy meters, displays and additional inverters.



INFO

The voltage output is not potential-free. It can deal with a max. load of 100 mA.



INFO

Either a PIKO Sensor **or** a ripple control receiver can be connected to the analog inputs Ain1 - Ain4.



INFO

When using the S0 input, the analog inputs Ain3 and Ain4 are inactive.

A ripple control receiver can nonetheless be connected.

Connection options of RJ45 sockets

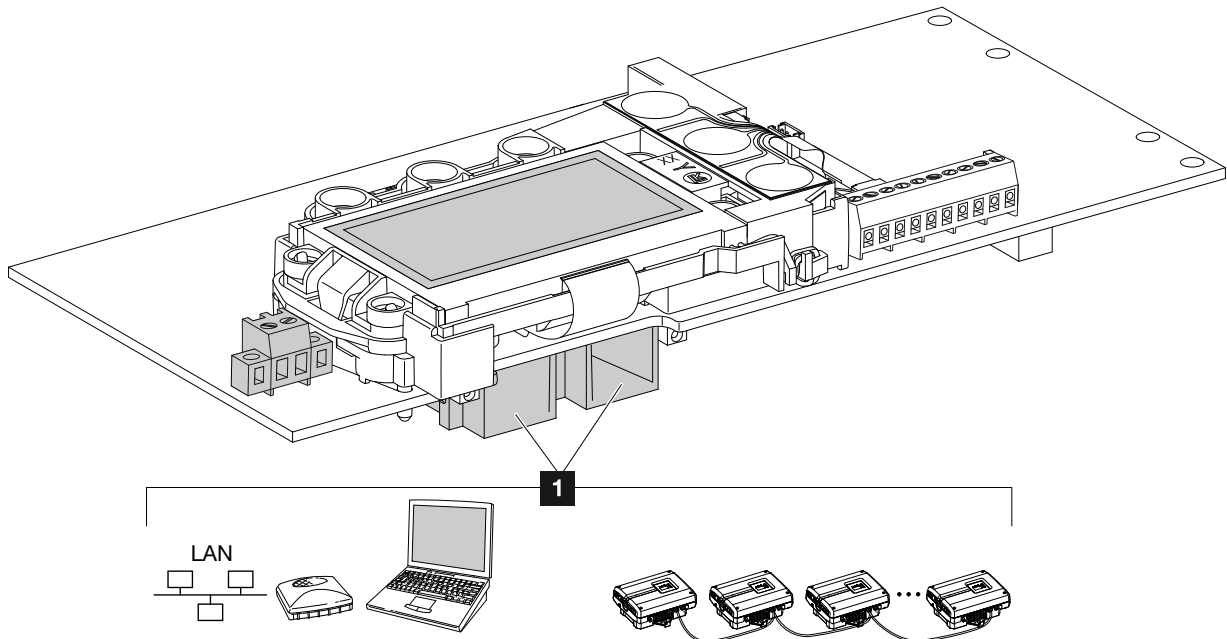

Fig. 36: Assignment of connection sockets

- 1 Socket RJ45:** connection of computer, LAN, router, switch, hub and/or additional inverters. The connection to a computer or computer network can be established via the RJ45 connection. **i** Several inverters can be connected to a network for data retrieval.



INFO

For connection with a computer or computer network (Ethernet 10BaseT, 10/100 MBit/s), an Ethernet cable of category 6 (Cat 6, FTP) with a max. length of 100 m is to be used.

Connection options of RS485 sockets

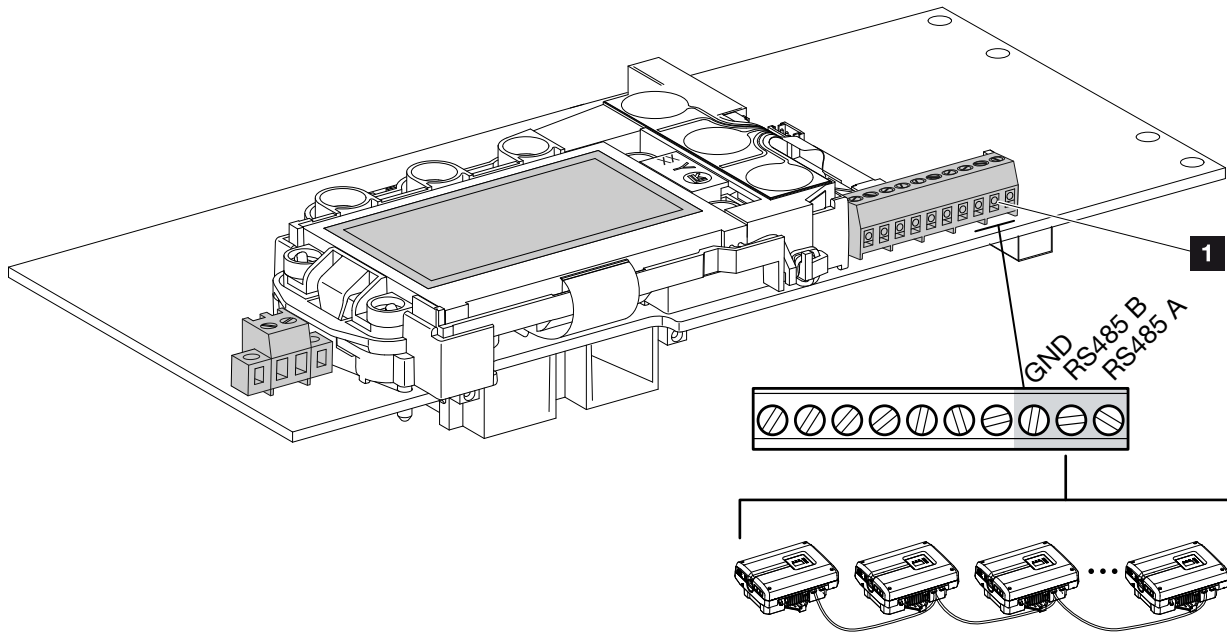

Fig. 37: Assignment of RS485 connection sockets

1 RS485 socket: connection of data loggers or other inverters.

A connection with other inverters can be established via the RS485 connection.

Several inverters can be connected to a network for data retrieval.

3.9 Initial commissioning

Procedure for initial commissioning

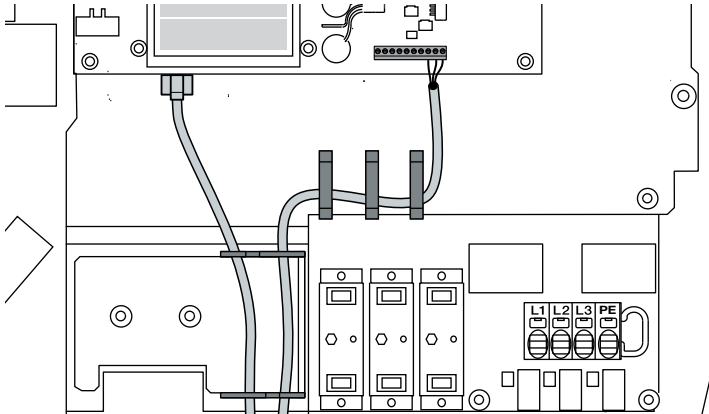





Fig. 38: Check wiring

1. Tighten all cable glands and check that they are properly sealed.
 2. Check the fit of connected wires and braids.
 3. Remove any foreign objects (tools, wire cuttings, etc.) from the inverter.
 4. Install the cover and screw it tight (5 Nm). 
 5. Plug the sockets and plugs of the DC strings onto the inverter.  **Fig. 34**
 6. Activate the supply voltage via the line circuit breaker.
 7. Switch the DC switch of the inverter to ON.  **Fig. 35**
If external DC voltage separators are present, activate the DC strings consecutively.
- The screensaver appears on the display and displays the device type.
8. The screensaver is deactivated when any key is pressed twice. 
- The "Language" menu appears on the display.



IMPORTANT INFORMATION

At least the "Min. input voltage (U_{DCmin})" must be present for initial commissioning. The output must be able to cover the inverter's self-consumption during initial commissioning.



IMPORTANT INFORMATION

If incorrectly assembled, the screws securing the cover may seize and destroy the thread inside the housing. Tighten the cover screws crosswise and do not fully tighten them immediately. This will make the cover more centred on the housing and prevent the screws inside the housing from seizing.



INFO

The installation process can vary depending upon the software version of the inverter.

Information on using the menu:

 **Ch. 4.4**

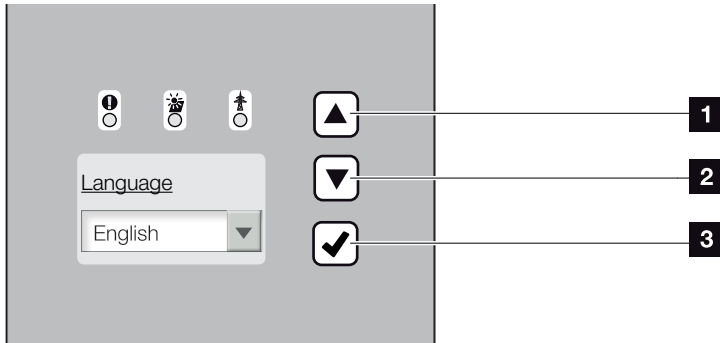

Fig. 39: Display on the inverter

- 1** "UP" arrow key
 - 2** "DOWN" arrow key
 - 3** "ENTER" key
- 9.** Select language and confirm.
 - The "Date/time" menu appears on the display.
 - 10.** Set date and time and confirm. **i**
 - The "Overvoltage protection" menu appears on the display.
 - 11.** Activate overvoltage protection for DC and/or AC, if this has been installed. **i**
 - The "Country setting" menu appears on the display.
 - 12.** Select and confirm the desired country/standard/directive.
 - A confirmation field for the "Country setting" appears on the display.
 - 13.** In order to save the country setting, select and confirm the confirmation field "Yes". **i**
 - ✓ The settings are assumed by the inverter.

The inverter is in operation and can now be used. Initial commissioning is completed.



INFO

The entry of date/time ensures that the downloaded log data has the correct time assigned to it.



INFO

The inverter is supplied without overvoltage protection modules. However, these can be subsequently retrofitted for the AC and DC sides in the inverter. Once the overvoltage protection is activated, it is monitored by the inverter. For more information [Ch. 8.6](#)



INFO

Once the country setting has been confirmed, it can only be changed by an installer or by entering the service code.

4. Operation and operating the device

4.1	Switching on the inverter	55
4.2	Switching off the inverter	56
4.3	De-energising the inverter	57
4.4	Control panel	58
4.5	Operational status (display)	61
4.6	Operational status (LEDs)	62
4.7	The menu structure of the inverter	63
4.8	The service menu	67
4.9	The energy management system in the inverter	68
4.10	Event codes	69

4.1 Switching on the inverter

1. Activate supply voltage via the line circuit breaker.
2. Move DC switch on inverter to ON position.

Fig. 10

When external DC voltage separators are present, activate the DC strings consecutively.

- The inverter starts up.
- During start-up, the three LEDs in the control panel of the inverter will light up briefly. The inverter can now be operated.
- The screensaver appears on the display and displays the device type. The screensaver is deactivated when a key is pressed twice. 
- ✓ The inverter is in operation.



INFO

When no key has been pressed for several minutes, the screensaver with the image of the inverter appears automatically on the display.

4.2 Switching off the inverter

In order to switch off the inverter, carry out the following steps. Additional steps are necessary for maintenance or repair work on the inverter.  **Ch. 4.3.**

1. Turn the DC switch on the inverter to OFF.  **Fig. 11**
2. If external DC voltage separators are present, switch off the DC strings consecutively.

4.3 De-energising the inverter

When working on the inverter or the feed cables, the inverter must be completely de-energised. ⚠

It is imperative that these steps are carried out:

1. Turn the DC switch on the inverter to OFF.  **Fig. 11**
2. Switch off the AC line circuit breaker.
3. Switch off the power supply for the S0/AL-Out output (if present).
4. Secure the entire voltage supply against being restarted.
5. Disconnect all DC connections on the inverter. To do this, unlock the engaging clips with a screwdriver and disconnect the plug. ¹

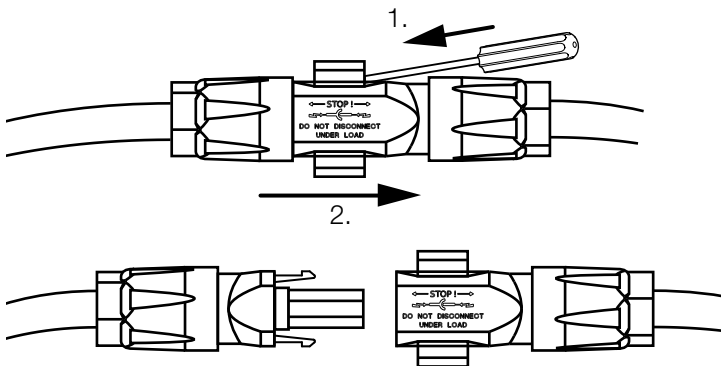

Fig. 40: Disconnecting SUNCLIX plug

6. Wait five minutes until the capacitors of the inverter have discharged. Allow the device to cool down.
 7. Ensure that all connections are voltage-free.
- ✓ The inverter is de-energised. Work on the inverter or on the feed cables can now be carried out.



DANGER

RISK OF DEATH DUE TO ELECTRICAL SHOCK AND DISCHARGE!

De-energise the device, secure it against being restarted and wait five minutes so that the capacitors can discharge.

¹Information available online at www.phoenixcontact.com

4.4 Control panel

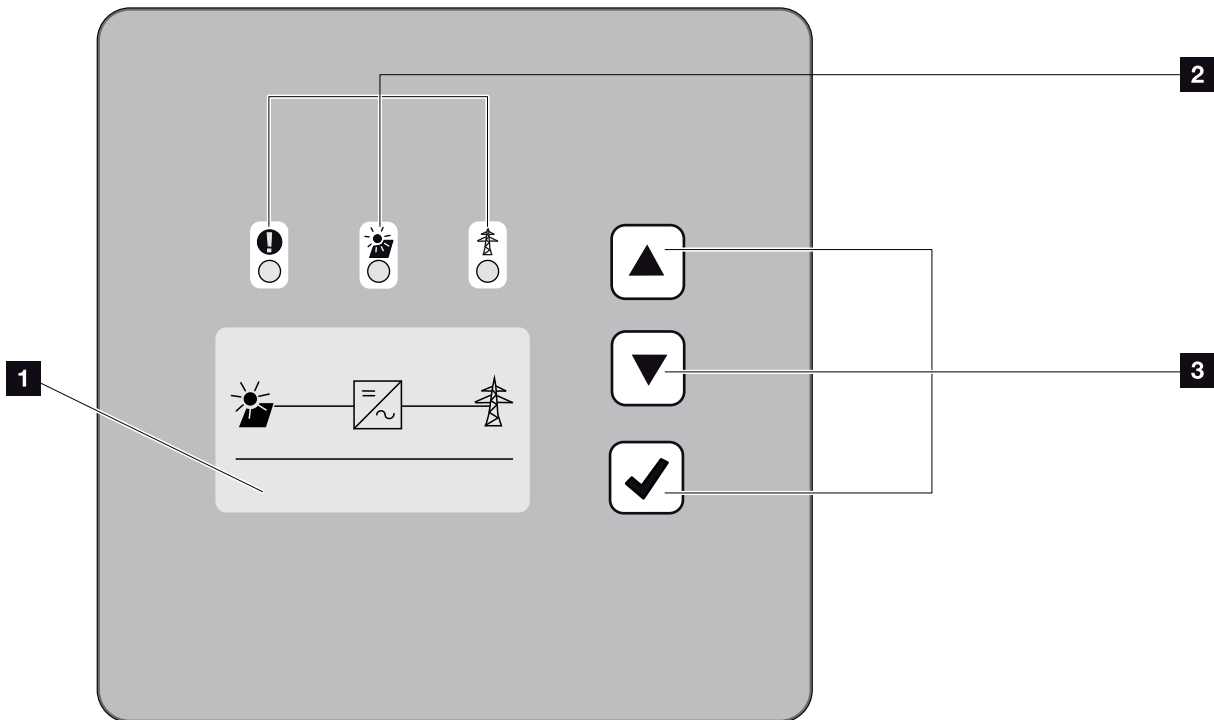

Fig. 41: Control panel

- 1** Display (display dependent upon the inverter type)
- 2** "Fault" LED (red)
"DC" LED (yellow)
"AC" LED (green)
- 3** Arrow key "UP"
Arrow key "DOWN"
Key "ENTER"

The inverter indicates the respective operational status through three LEDs and the display. **i**

The operating values can be retrieved and settings adjusted on the display.



INFO

When no key has been pressed for several minutes, the screensaver with the image of the inverter appears automatically on the display.

Operation of the display

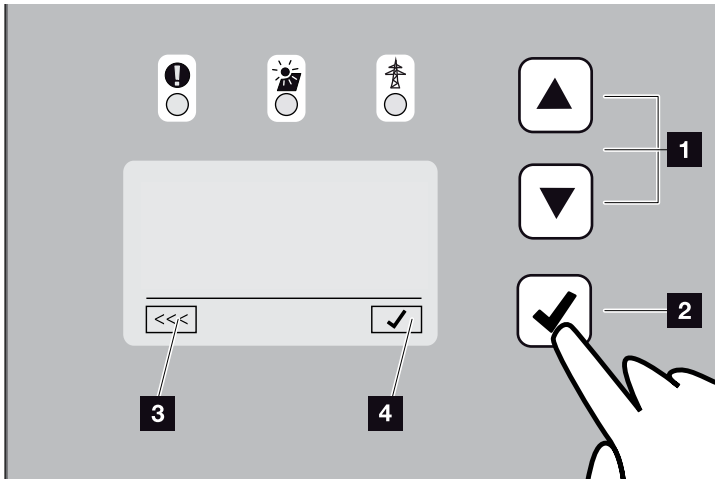

Fig. 42: Operation of the display

- 1 UP/DOWN:** Characters, buttons and input fields are selected with the arrow keys.
- 2 ENTER: Briefly pressing** the "ENTER" key activates the selected menu element or confirms the entry at the end.
Pressing "ENTER" for an **extended time** confirms the entry.
- 3 Back:** This function can be used to jump to the higher level menu. Values entered in the menu must be saved in advance, otherwise these will not be adopted.
- 4 Confirm:** Values are adopted or the selected function confirmed with this function.

Entry of text and numbers

The display can also be used to enter texts and numbers (e.g. inverter name and portal code). The table below explains the functions for the entry of text and numbers.



Object with a dashed line means: Object is selected and can be activated with "ENTER".



Object with black background means: Object is active and can be edited.



Character with a black background means: Character is selected and can be changed with the arrow keys.



Characters in text fields are deleted with this function. To this end, go to after the last character and press an arrow key (the character << appears in the text field). The characters can now be deleted by pressing the "ENTER" key.

4.5 Operational status (display)

The operational statuses are shown on the display of the inverter:

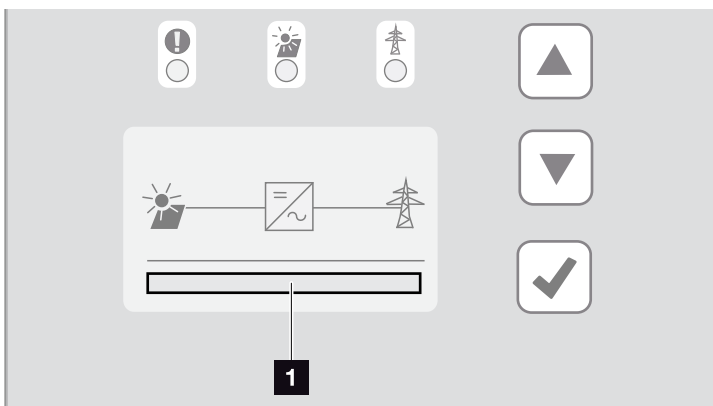

Fig. 43: "Operational status" display area

1 Display area showing the operational statuses

The following table explains the operational notifications that can appear on the display:

Display	Explanation
Off	Input voltage on the DC side (photo-voltaic modules) is too low
Standby	Electronics are ready for operation, DC voltage or DC power is still too low for feed-in
Starting	Internal control measurements according to VDE 0126
Feed-in (MPP)	Measurement successful, MPP control active (MPP = maximum power point)
Feed-in regulated	Feed-in is regulated on the basis of a fault (e.g. PV energy is limited Ch. 7 , excess temperature, fault)
Event code xxxx	An event is present. Remedial measures can be found in the "Event codes" chapter Ch. 4.10

Tab. 4: Operational notifications on the display of the inverter

4.6 Operational status (LEDs)

The LEDs on the front of the device indicate the current operational status.

LEDs on the inverter

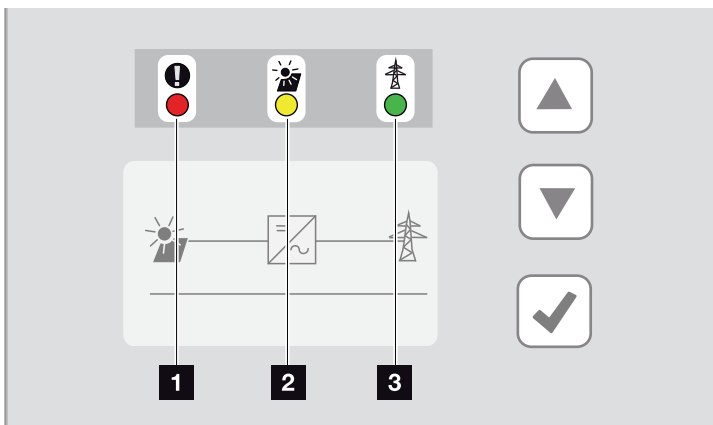

Fig. 44: LEDs on the display of the inverter

1 "Fault" LED flashes or lights up red:

A fault has occurred. Remedial measures can be found in the "Event codes" chapter [Ch. 4.10](#)

2 "DC" LED lit yellow: The yellow LED signals the active status of the inverter control unit. It lights up as soon as the minimum input voltage (V_{DCmin}) is present at one of the DC inputs but the inverter is not yet feeding.

"DC" LED flashes yellow: A fault has occurred. Remedial measures can be found in the "Event codes" chapter [Ch. 4.10](#)

3 "AC" LED lit green: The green LED signals the feed-in mode of the inverter.

No LED is lit: The device is ready for operation, but the input voltage is too low [Ch. 9.1](#).

OR: The device is switched off.

4.7 The menu structure of the inverter

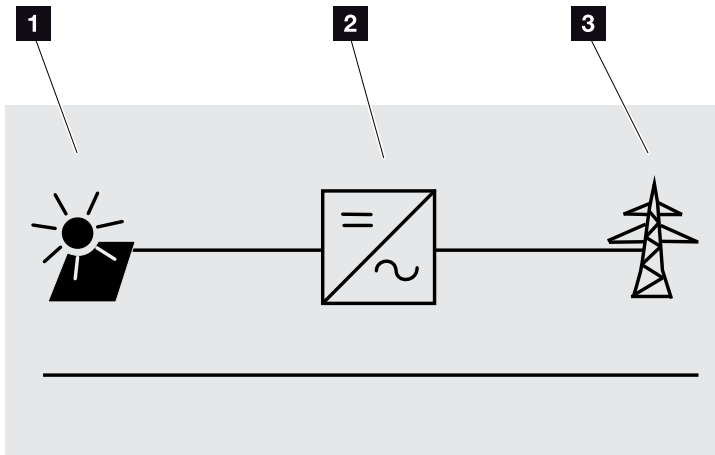

Fig. 45: Main menu structure on the display

- 1** DC menu
- 2** Settings menu
- 3** AC menu

The menus* are listed individually on the following pages.

* Deviations due to software versions (UI status) possible.

DC menu



DC input 1 (V,I,P)¹

DC input 2 (V,I,P)¹

DC input 3 (V,I,P)¹

AC menu



Phase 1 (V,I,P)

Phase 2 (V,I,P)

Phase 3 (V,I,P)

Total yield ———— Yield (Wh)

Operation time (h)

Grid parameter ———— Limitation on (%)

Grid frequency (Hz)

cos φ

Daily yield (diagram)

Monthly yield (diagram)

Annual yield (diagram)

Total yield (diagram)

¹ The following DC inputs are connected in parallel internally in the inverter and are each shown as a string.
DC1 (DC1 and DC2), DC2 (DC3 and DC4), DC3 (DC5 and DC6)

Settings menu

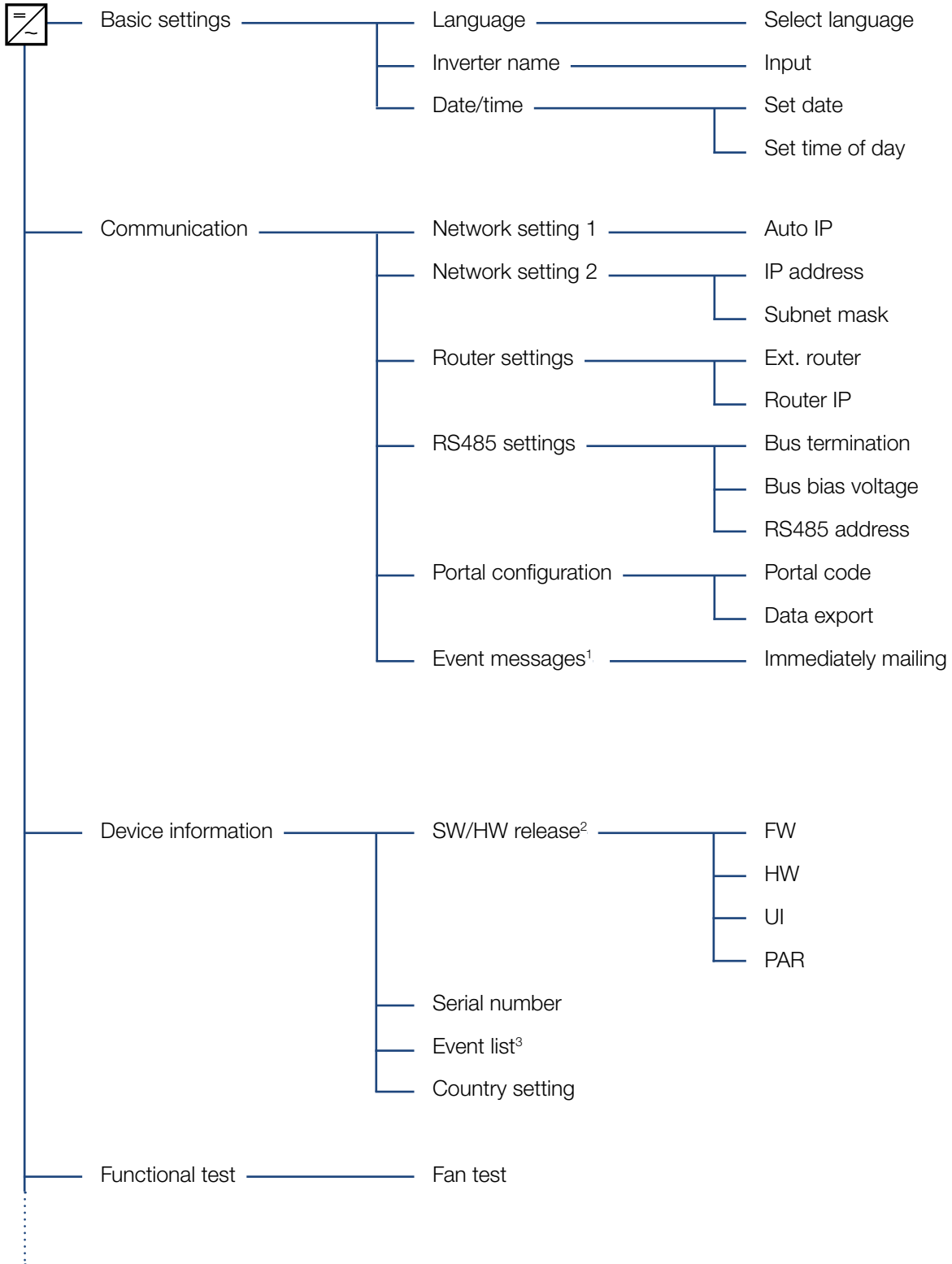

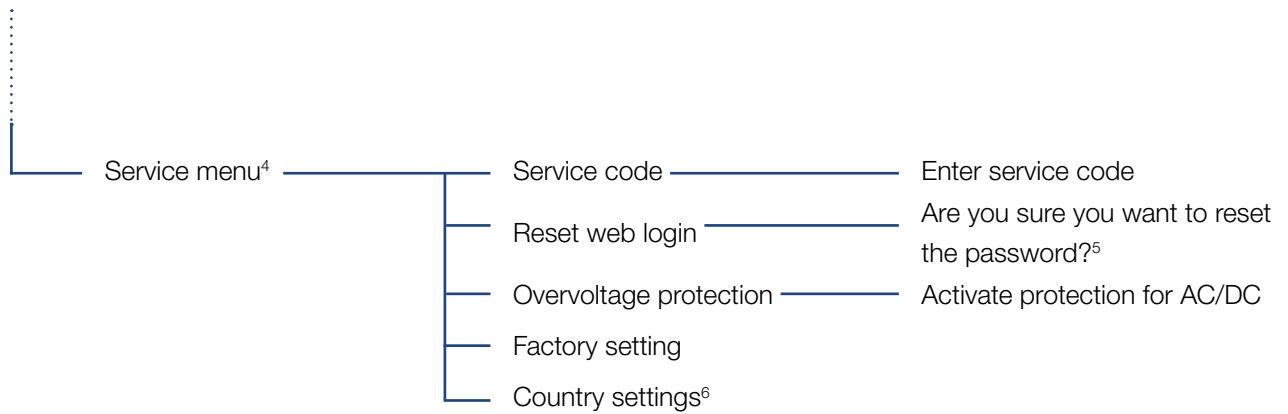

¹ Event messages can be faults or other events. The "Immediately mailing" option sends the event message immediately following the data capture period to a selected Internet portal.

² SW/HW release, FW: Firmware release, HW: Hardware release, UI: Software release of the communication board, PAR: Version of the parameter file

³ A maximum of 10 events are displayed. Information about events can be found in the "Event codes" chapter.

⁴ Following entry of a code, additional menu items for configuring the inverter appear. The code can be requested for installers from the Service team.

⁵ The Webserver password for the "pvserver" user is reset to the default values "pwvr" .

⁶ Only visible once the service code has been entered.

4.8 The service menu

Using the inverter's service menu, the installer can perform settings on the inverter, which are not available to the normal user.

In order that the service menu and other service settings, that only an installer can make, are displayed in the communication board, the installer must request a code via the inverter manufacturer's service.

The code is entered by going to the following menu item:
Settings > Service menu > Service code

Once the service code has been entered and confirmed, the additional service menu entries appear. 

Below you will find a description of the functions and settings available:



INFO

The service menu entries depend on the installed inverter firmware (FW) and the communication board software (UI) and may deviate from the description provided here.

Service menu entry	Description
Service code	Input of service code and enabling of additional menu items.
Reset web login (possible without service code)	Reset Webserver login to default values. Default values for Webserver login: User " pvserver " Password " pvwr "
Overvoltage protection (possible without service code)	Activate overvoltage protection for AC and/or DC. This must be installed in the inverter in advance.
Factory setting (possible without service code)	Reset inverter to factory setting. All settings are deleted apart from the country setting.
Country setting	Reset the country setting. Once the reset is complete, the inverter reports back with the country setting.

4.9 The energy management system in the inverter

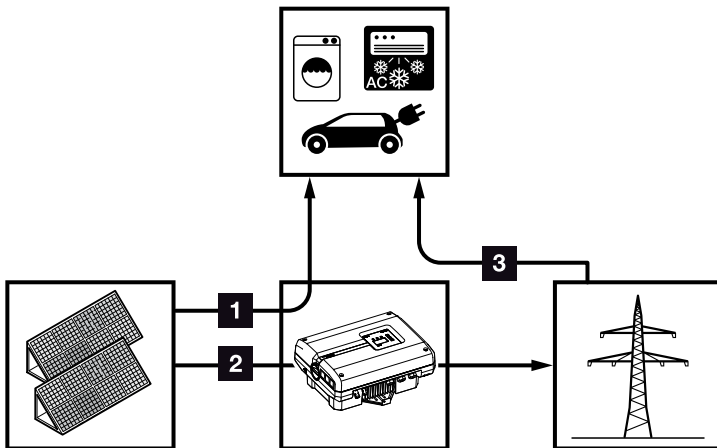



Fig. 46: Control and distribution of the energy flows

- 1 PV energy:** Consumption via local consumers
- 2 PV energy:** Feed-in to the public grid
- 3 Grid energy:** Consumption via local consumers

The energy management system (EMS) controls the distribution of the energy between the DC side (solar generator) and the AC side (building grid, public grid). For this purpose, the EMS checks for the presence of consumption in the internal home network. The logic of the EMS then calculates and controls the optimal usage of PV energy.

The generated PV energy is primarily used for consumers (such as light, washing machine or television). The remaining generated PV energy is fed into the grid and remunerated.

4.10 Event codes

There is no need to take action when an event occurs occasionally or only briefly and the device resumes operation. When an event occurs over long periods or recurs frequently, the cause must be determined and rectified. 

In case of a permanent event, the inverter interrupts the feed-in and switches off automatically.

- Check whether the DC switch or the external DC voltage separator has been switched off.
- Check whether the event is due to a mains power failure, or whether the fuse between the feed meter and the inverter has tripped.

If the fuse has tripped, notify the installer; if there is a power failure, simply wait until the grid operator has corrected the problem.

If the event lasts only a short time (grid fault, overheating, overload, etc.), then the inverter will automatically resume operation as soon as the event has been resolved.

If the event persists, notify your installer or the manufacturer's customer support team. 

Provide the following information:

- Device type and serial number. You will find this information on the type plate on the exterior of the housing.
- Description of fault (LED display and display message).

The type of event can be determined on the basis of the message in the display "Event code: xxxx" and the following table.

In the case of events not listed in the table, please contact the Service team.



DANGER

RISK OF DEATH DUE TO ELECTRICAL SHOCK AND DISCHARGE!

Life-threatening voltages are present in the inverter. Only a qualified electrician may open and perform work on the device.



INFO

You can find contact details in the chapter "Warranty and service":

 **Ch. 11.2**

Event code	LED display	Type of event	Description/ possible cause	Measure
3000		Update process fault	Internal system fault	Perform inverter update.
3003		Internal communication fault	Internal communication fault between grid monitoring and control system	Check internal communication cables between the individual PCBs ¹
3006		Internal system fault	Internal system fault with respect to power curtailment	Device carries out a test several times and generally overrides. Support ¹
3010		Internal communication fault	Internal communication fault between control system and communications PCB	Check the time setting, function of the communications PCB and other communication settings. Inverter switches despite incorrect time stamp ¹
3012		Varistor fault	DC varistor defective	Replace defective varistor ¹
3013		Internal temperature fault	Excess temperature AC/DC at power level	Check installation conditions and fan ¹
3014		Internal temperature fault	Overheating of processor	Check installation conditions and fan ¹
3017		External generator fault	Overvoltage on PV generator	Check generator installation/layout ¹
3018		Information	Power curtailment through external specifications (grid operator)	No action necessary.
3019		External grid fault	Power curtailment due to a grid fault (increased grid frequency)	Support ¹
3020		Information	Overcurrent on the PV generator	Check generator installation/layout ¹
3022		External generator fault	Overvoltage on PV generator	Check generator installation/layout ¹
3023		Information	Overcurrent on the PV generator	Check generator installation/layout ¹
3025		External generator fault	Overvoltage on PV generator	Check generator installation/layout ¹
3026		Information	Overcurrent on the PV generator	Check generator installation/layout ¹
3032		External generator fault	Overcurrent on the PV generator	Check generator installation/layout ¹
3033		Internal system fault	Internal system fault	Support ¹
3039		Internal parameterization fault	Internal system fault	Contact support
3045		Internal system fault	Internal AC system fault	Device carries out test several times and generally overrides ¹
3048		Internal communication fault	Internal communication error	Check the internal communication cables between the individual PCBs ¹

Event code	LED display	Type of event	Description/ possible cause	Measure
3049		Internal communication fault	Internal communication error	Check the internal communication cables between the individual PCBs ¹
3050		Internal communication fault	Internal communication error	Check the internal communication cables between the individual PCBs ¹
3055		Internal system fault	Internal system fault	Restart the device ¹
3056		Internal parameterization fault	Internal system fault	Contact support
3057		Internal system fault	Internal system fault	Check generator installation/layout ¹
3059		Internal parameterization fault	Incorrect parameterization	Country setting may be incorrect. Contact support
3060		Internal parameterization fault	Incorrect parameterization	Contact support
3062		Internal temperature fault	Internal system fault	No action necessary ¹
3063		Internal parameterization fault	Internal system fault	Contact support
3076		Information	Internal AC system fault	The AC voltage may be too low.
3079		Internal system fault	Internal system fault	Restart the device ¹
3082		Internal system fault	Internal system fault	Contact support
3083		Information	Internal system fault	No action necessary ¹
3085		Internal temperature fault	Overheating of processor	Check installation conditions and fan ¹
3086		Information	Power curtailment due to a grid fault (increased AC voltage)	Support ¹
3087		Internal system fault	Internal system error	Contact support
3088		Internal system fault	Fan unit dirty	Clean fan unit
3093		Internal parameterization fault	Incorrect parameterization	Contact support
3094		Internal parameterization fault	Incorrect parameterization	Contact support

Event code	LED display	Type of event	Description/ possible cause	Measure
3095		Internal parameterization fault	Incorrect calibration	Contact support
3096		Information	Incorrect dimensioning of PV generator	Check generator installation/layout
3097		Internal parameterization fault	Incorrect parameterization	Contact support
3101		Information	Internal system fault	No action necessary ¹
3104		Internal system fault	Internal AC system fault	Device carries out a test several times and generally overrides ¹
3107		Internal system fault	Overvoltage protection modules defective or not fitted	Replace or fit overvoltage protection modules
3108 - 3124		Internal system fault	Internal AC system fault	Contact support
3129		Internal system fault	Internal system fault	No action necessary ¹
3130		Internal system fault	Power curtailment through external specifications (grid operator)	No action necessary ¹
3131		Internal system fault	Power curtailment through external specifications (grid operator)	No action necessary ¹
3132		Internal temperature fault	Inverter overheating	Check the fan ¹
4100		Internal system fault	Internal software error	Support ¹
4101		Internal system fault	Increased DC current L1	Support ¹
4102		Internal system fault	Increased DC current L2	Support ¹
4103		Internal system fault	Increased DC current L3	Support ¹
4104		Internal system fault	Increased DC current L1	Support ¹
4105		Internal system fault	Increased DC current L2	Support ¹
4106		Internal system fault	Increased DC current L3	Support ¹
4110		Internal system fault	Internal software error	Support ¹
4131		Internal system fault	Internal system fault	Support ¹
4150		Information	Increased grid frequency. Frequent recurrence in the morning and the evening.	Check the installation ¹

Event code	LED display	Type of event	Description/ possible cause	Measure
4151	● ○ ○	External grid fault	Grid frequency too low	Check the installation ¹
4157	○ ○ ○	External grid fault	Increased grid frequency	No action necessary ¹
4158	● ○ ○	External grid fault	Increased grid frequency	Check the installation ¹
4159	● ○ ○	External grid fault	Increased grid frequency	Check the installation ¹
4160	● ○ ○	External grid fault	Increased grid frequency	Check the installation ¹
4161	● ○ ○	External grid fault	Grid frequency too low	Check the installation ¹
4170	○ ○ ○	Information	One phase is not connected. A miniature circuit breaker was not switched on.	Check the installation ¹
4200	● ○ ○	External grid fault	Increased supply voltage	Check the installation ¹
4201	● ○ ○	External grid fault	Supply voltage too low	Check the installation ¹
4210	● ○ ○	External grid fault	Increased supply voltage	Check the installation ¹
4211	● ○ ○	External grid fault	Supply voltage too low	Check the installation ¹
4220	● ○ ○	External grid fault	Voltage mean value of the last 10 minutes too high	Check the installation ¹
4221	● ○ ○	External grid fault	Voltage mean value of the last 10 minutes too high	Check the installation ¹
4290	● ○ ○	External grid fault	The grid frequency has changed too quickly.	Check generator installation ¹
4300	● ☀ ○	Internal system fault	Internal system fault	Support ¹
4301	● ☀ ○	Internal system fault	Internal system fault	Support ¹
4302	● ☀ ○	Internal system fault	Internal system fault	Support ¹
4303	● ☀ ○	Internal system fault	Internal system fault	Support ¹
4304	● ☀ ○	Internal system fault	Internal system fault	Support ¹
4321	● ☀ ○	Internal parameterization fault	Defective EEPROM, forbidden memory access	Support ¹
4322	● ☀ ○	Internal parameterization fault	Software error	Contact support
4323	● ☀ ○	Internal parameterization fault	Residual current	Support ¹

Event code	LED display	Type of event	Description/ possible cause	Measure
4324		Internal parameterization fault	Parameter error	Support ¹
4325		Internal parameterization fault	Parameter error	Support ¹
4340 - 4351		External residual current	Residual current	Check generator installation ¹
4360 - 4421		Internal system fault	Internal system fault	Support ¹
4422		Internal system fault	Internal system fault	Contact support.
4424		Internal system fault	Internal system fault	Support ¹
4425		Internal parameterization fault	Parameter error	Support ¹
4450		External insulation fault	Insulation fault	Check generator installation ¹
4451		Internal system fault	Internal system fault	Contact support
4475		Internal system fault	Internal system fault	Support ¹
4476		Information	Weak PV supply (e.g. in the morning)	No action necessary ¹
4800		Internal system fault	Internal system fault	Support ¹
4801		Internal system fault	Insulation fault	Support ¹
4802		Internal system fault	Internal system fault	Support ¹
4803		Internal system fault	Insulation fault	Support ¹
4804		Internal system fault	Insulation fault	Support ¹
4805		Internal system fault	Internal system fault	Support ¹
4810		Internal system fault	Internal system fault	Support ¹
4850		Internal system fault	Energy supply company	Support ¹
4870 - 4909		Internal system fault	Internal system fault	Support ¹

Tab. 5: Event codes

¹ If the error occurs several times/permanently, please contact Support.

Legend for the "Event codes" table

 LEDs flashing

 LEDs lit up

 LEDs off

5. Webserver

5.1	The Webserver	77
5.2	Using the Webserver	78
5.3	Connecting the inverter and computer	79
5.4	Calling up Webserver	80
5.5	Disconnecting the inverter from the computer	81
5.6	Menu structure in Webserver	82
5.7	Webserver main menu	84
5.8	Webserver submenus	85

5.1 The Webserver

The Webserver forms the graphic interface (shown in the browser) between the inverter and the user.*

* Deviations due to software versions (UI status) possible.



Fig. 47: Webserver

- 1 Selection of language
- 2 Logged-in user
- 3 Inverter name
- 4 Menu
- 5 Values/input boxes
- 6 "Reset" button clears the input and resets it to the previous value.
- 7 "Accept" button saves and accepts all changes

The Webserver* allows the user to view key information, current values, events and versions (e.g. user interface, firmware or hardware) relating to the inverter. The statistics provide a summary of the yield and operating duration and also provide the log data, which supplies other information. The inverter can also be quickly and easily configured in the Settings.

5.2 Using the Webserver

The Webserver is accessed on the inverter from a computer using a web browser (e.g. Internet Explorer). Both devices must be on the same network. 

Settings in the computer¹

- In the Internet protocol (TCP/IP) of the computer, the options "Automatically acquire IP address" and "Automatically acquire DNS server address", must be activated. 

You can go to the settings for the Internet protocol (TCP/IP) via the control panel: 

Control Panel >> Network and Sharing Centre >> Change Adapter Settings.

Right-click on the LAN connection >> Properties >> Select "Internet protocol (TCP/IPv4)" > Properties.

- In the LAN settings of the computer, the option "Use proxy server for LAN" must be deactivated.

You can reach the "LAN settings" via the control panel: Control Panel >> Internet options >> Tab: "Connections" >> LAN settings.



TIP

Any device (e.g. a tablet PC) that has a browser (e.g. Internet Explorer 11 or Firefox 50), can be used to access the Webserver.

¹ With Windows 10



INFO

If the computer can already access the network in which the inverter is installed, these settings are not required.



INFO

The control panel can be called up under Windows 10 by right-clicking on the Windows symbol.

5.3 Connecting the inverter and computer

Connecting inverter with computer

1. De-energise the inverter. 
2. Open the inverter cover.

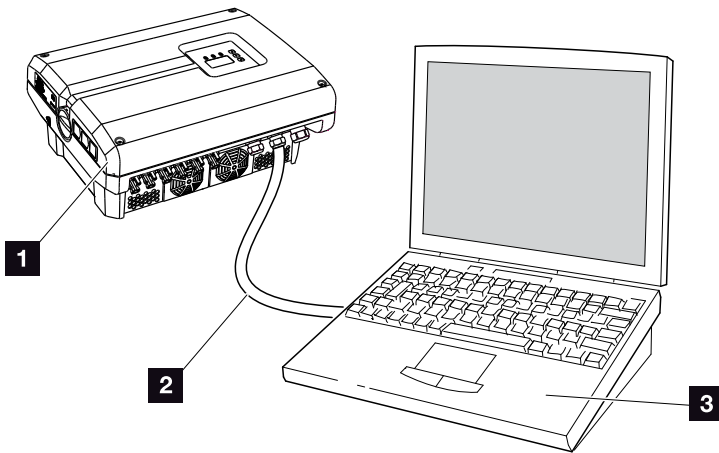



Fig. 48: Connecting inverter and computer with an Ethernet cable

- 1** Inverter
 - 2** Ethernet cable
 - 3** Computer (for configuration or data retrieval)
3. Connect the Ethernet cable to the RJ45 interface of the communication board. 
 4. Connect the Ethernet cable to the computer.
 5. Close the inverter cover.
 6. Activate fuses and DC switch.
- ✓ The inverter is connected to the computer.



TIP

You can find additional variants for connecting the inverter with a computer here  [Ch. 6.1](#)



DANGER

RISK OF DEATH DUE TO ELECTRICAL SHOCK AND DISCHARGE!



De-energise the device, secure it against being restarted and wait five minutes so that the capacitors can discharge.  [Ch. 4.3](#)



IMPORTANT INFORMATION

If the computer and the inverter are connected directly with an Ethernet cable, the adjacent work sequence must be followed!

5.4 Calling up Webserver

1. Launch an Internet browser.
2. Enter the IP address of the inverter in the address line of the browser and confirm with "Enter". 
- The Webserver is called up.
3. To log in, click on Login and select a user. The following login data are preset as "Plant owner" as standard:
 - User name: pvserver**
 - Password: pwvr**
 Enter the user name and password. 
- The Webserver's menu opens.

Undertaking settings in the Webserver

After logging in, the settings required can be undertaken on the inverter or values can be queried via the Webserver.



TIP

The IP address can be queried in the inverter menu under "Settings/Communication/Network settings 2".

Additional entry options in the address line of the browser:

- S and the serial number of the inverter on the type plate (example: `http://S12345FD323456`)
- Name of the inverter: The inverter can be assigned a name. This may be no longer than 15 characters and may not contain special characters like + - * /... (For example: `http://SWR_5`).



IMPORTANT INFORMATION



The password should be changed once you have logged in for the first time under Settings.

The password may consist of no more than 15 characters and contain the following characters: a-z, A-Z, 0-9 and _

You need a service code to log in as an installer. This can be requested from the Service team.  **Ch. 11.2**

Should you forget the password, this can be reset to the default values on the inverter by going to Service menu > "Reset web login".  **Ch. 4.8**

5.5 Disconnecting the inverter from the computer

1. De-energise the inverter.
 **Ch. 4.3**  
 2. Open the inverter cover.
 3. Unplug the Ethernet cable from the inverter and the PC.
 4. Close the inverter cover.
 5. Activate fuses and DC switch.
- ✓ The inverter is once again in operation.



TIP

Leave the Ethernet cable connected to the inverter. This makes it possible to easily carry out further queries or setting configurations on the inverter.

If connecting through a router, for example, there is no need to remove the connection.



DANGER

RISK OF DEATH DUE TO ELECTRICAL SHOCK AND DISCHARGE!

De-energise the device, secure it against being restarted and wait five minutes so that the capacitors can discharge.  **Ch. 4.3**

5.6 Menu structure in Webserver

The menus* of the Webserver are explained on the following pages.

* Deviations due to software versions (UI status) possible.

Home menu



Home

Displays inverter status and the current power values

Current values menu



Current values

PV generator

Displays voltage, current, power for each DC input

Grid

Displays voltage, current, power for each phase and total fed into the public grid.

Analog inputs

Displays voltages at the analog inputs on the communication board

S0 input

Displays the function of the S0 input and the associated values

Statistics menu



Statistics

Day

Displays yield for the current day

Total

Displays total yield

Log data

Displays the history/log data stored in the inverter

Settings menu

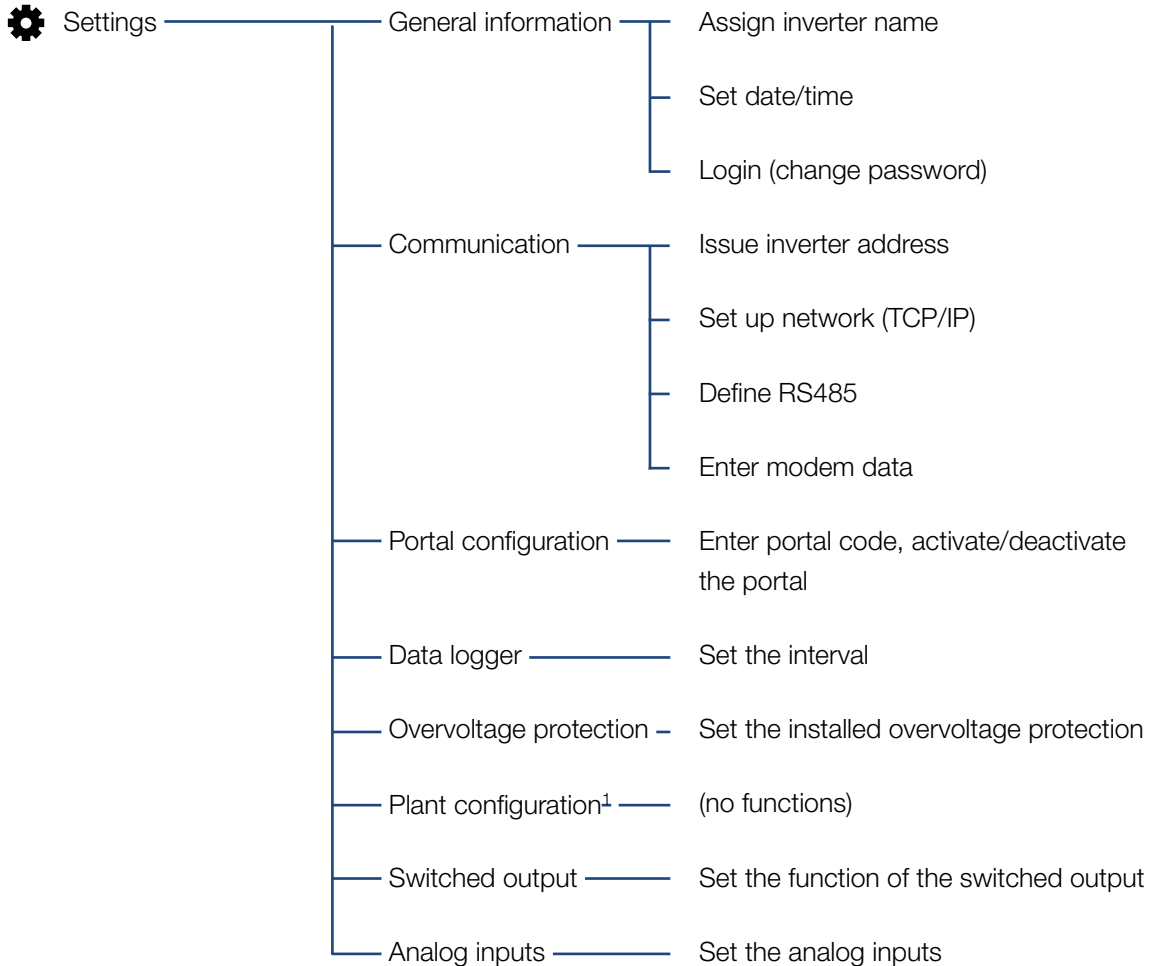

Info menu

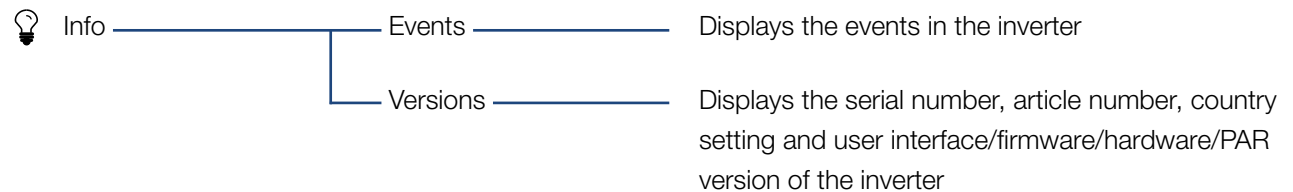

Logout menu



¹ These settings are only possible with a service code

5.7 Webserver main menu

- **Home**

Displays the key information and yield data for the inverter.
- **Current values**

The various menu items allow the user to view the current values for the PV generators, the home consumption, the public grid connection, the analog interfaces and the use of the S0/AL-Out contact on the communication board.
- **Statistics**

Shows information about the inverter's yield data and the daily or total home consumption. "Log data" shows the inverter's history data or stores it on the computer.
- **Settings**

These menu items allow you to configure the inverter (e.g. inverter name, network settings).
- **Info**

On the Info page the user can view events pending in the inverter or the inverter's installed versions (e.g. user interface, firmware, hardware). This information can also be viewed without logging into the Webserver.
- **Login/Logout**

Allows the user to log into or out of the Webserver.
Login: Log into the Webserver. You can log in as a plant owner or as an installer. As an installer you require a service code, which gives you additional setting options on the inverter.
Logout: Menu item to log out of the Webserver.

5.8 Webserver submenus

Webserver page "Login/Logout"

Allows the user to log into or out of the Webserver.

- **Login:** Log into the Webserver. You can log in as a plant owner or as an installer. As an installer you require a service code, which gives you additional setting options on the inverter. 
- **Logout:** Menu item to log out of the Webserver.



INFO

You need a service code to log in as an installer. This can be obtained from the Service team.

 **Ch. 11.2**

Webserver page "Home"

- Displays information and yield data for the inverter.

Parameter	Explanation
Power values - total DC input	Displays the generated energy of all PV generators.
Power values - output power	Shows how much power is fed into the public grid.
Status - operating status	Operational status of inverter. For more information, see  Ch. 4.4.

Webserver page "Current values"

Menu items to display the current energy values of the AC and DC side.

- **PV generator**

Displays the generated voltage, current and energy of the PV generators per DC input. 

- **Grid**

Shows the current performance data of the grid side (AC) and how the energy is distributed to the phases.

Parameter	Explanation
Output power	Shows how much power is fed into or drawn from the public grid.
Grid frequency	Shows the current grid frequency.
Cos phi	Indicates the current reactive power (cos phi).
Limitation on	Shows the current power curtailment setting.
Phase x	Indicates the power by phase (1, 2 or 3) that is covered by the PV modules and grid.

- **Analog inputs**

Shows the voltage which is currently available on the analog input x. The meaning of the voltage data depends on the sensor used. In the case of an irradiation sensor, for example, it may be the intensity of solar irradiation. (For more information, refer to the manual for the sensor).

- **S0 input**

The "Number of energy pulses" shows the number of energy pulses per time unit on the S0 interface. If an external energy meter is connected at the S0 input, for example, the energy counted by the meter can be queried.



INFO

The following DC inputs are connected in parallel internally in the inverter and are each shown as a string in the Webserver.

- DC1 (DC1 and DC2)
- DC2 (DC3 and DC4)
- DC3 (DC5 and DC6)

Webserver page "Statistics"

Displays the yield, daily consumption, total consumption and log data.

- **Day**

Shows the yield/consumption values for the current day.

Parameter	Function
Yield	Indicates the energy generated by the PV generators.

- **Total**

Shows all yield/consumption values that have accumulated in the inverter.

Parameter	Function
Yield	Indicates the energy generated by the PV generators.
Operation time	Indicates the run time of the inverter.

- **Log data**

The link calls up the measured values (log data). The log data of the inverter can be downloaded as a DAT file (logData.dat). The data in the file is in CSV format and can be viewed with any spreadsheet programme (e.g. Excel). For more information, see  **Ch. 6.2**.

Option "**Open**":

The data are displayed in a new or the same browser window.

Option "**Save**":

The data (LogDaten.dat) are saved on your hard drive. After saving, this data can be displayed and further processed. 



INFO

If the inverter is not connected to a solar portal, regular backup copies of the log data should be created.

Webserver page "Settings"

In Settings you can configure the inverter and the external components (e.g. sensor, ripple control receiver). 

- **General**

Set the general parameters of the inverter.

Menu item	Function
Inverter name	Enter the inverter name. The characters a-z, A-Z, 0-9 and "_" are permitted for the name change. Spaces or special characters are not possible. The browser connection to the Webserver can be established with the new name following the name change. Access with the serial number remains possible.
Date/time	Enter the time and date. It is possible to adopt the PC time using the button "Set to PC time".
Login	Change current password



INFO

The entries must be confirmed by clicking on the "Accept" button. The settings are then saved.

■ **Communication**

Set the communication parameters of the inverter.

Menu item	Function
Inverter address	Input RS485 address of inverter. When two or more inverters are connected via RS485, each inverter must be given its own RS485 address.
Network (TCP/IP)	Input network, gateway and DNS server configuration. Configuration of the inverter network interface (Ethernet). As the standard default setting, the option "Auto IP/DHCP" and "Router/Gateway" is activated. 



INFO

As the standard default setting, the option "Auto IP/DHCP" is activated. This means that the inverter acquires its IP address from a DHCP server or automatically generates an IP address.

If the inverter is not allocated an automatic IP address through a DHCP server, the inverter can be configured using "Manually".

The data necessary for configuration, such as IP, router and DNS addresses, can be found on your router/gateway.

If the inverter is connected to a "Router/Gateway", the "Router/Gateway" option must be activated.

If data export using "Inverter with modem" is selected, communication is carried out through an inverter's modem. This can be installed in your own or another inverter.

"Network info" shows the addresses which the inverter is currently using. If the router/gateway also functions as a DNS server, the same IP address is displayed under DNS Server 1. If an alternative DNS server is issued through the "Manually" setting, the IP address for this is displayed under DNS Server 2.

Network configuration

Auto-IP/DHCP

Manually

IP address:

Subnet mask:

Router/Gateway:

DNS Server:

Data export

Router/Gateway

Inverter with modem

Network info

IP address: 168.192.2.32

Subnet mask: 255.255.255.0

Router/Gateway: 168.192.2.1

DNS Server 1: 168.192.2.1

DNS Server 2: 0.0.0.0

MAC address: 00:80:41:ae:fd:7e

Menu item	Function
RS485	<p>Bus termination: The bus termination must be activated on devices which are at the end of the RS485 bus.</p> <p>Bus bias voltage: At least one device in an RS485 bus system must supply the bus voltage. Activation means that the inverter supplies the bus bias voltage.</p> <p>Protocol: Selection of protocol used on the bus. </p> <p>KOSTAL: Is used to make more PIKO inverters or an external data logger/energy manager accessible via the interface.</p> <p>Modbus: Is used to connect e.g. external data loggers/energy managers to the RS485</p> <p>Baud rate: Selection of the baud rate, which is to be used for the bus system.</p> <p>Inverter address: Shows the inverter's set RS485 address.</p>
Modem	This function is not supported by this device.



INFO

A precise description of the protocol used (e.g. TCP, RS485, KOSTAL, Modbus-RTU), can be requested from the Service team.

■ **Portal configuration**

Enter the solar portal configuration. If you want to use a solar portal, the log data and events can be sent to the solar portal. 

Menu item	Function
Portal code	Input box for the portal code of a solar portal (e.g. PIKO Solar Portal - P3421).
Active portal	Display of the active portal.
Last portal connection	Displays how many minutes ago the inverter last transferred data to the solar portal (when the function is active).
Data export	Removal of the "check" deactivates sending to the solar portal.

■ **Data logger** 

Choose from a saving interval of 5, 15 or 60 minutes.

■ **Overvoltage protection**

If overvoltage protection was fitted on the AC or DC side, it can be activated or deactivated here. If an overvoltage protection module on the AC or DC side fails, an event about is issued about this. For more information, see  **Ch. 8.6**.

■ **Plant configuration**

This function is not supported by this device.

■ **Switched output**

This function is not supported by this device.



INFO

The solar portal can only be used for inverters which are connected directly to the Internet or connected with one another by means of the Ethernet (LAN).





INFO

When 5 minutes is selected, the data can be saved for approximately 130 days. When 15 minutes is selected, the data can be saved for approximately 400 days. When 60 minutes is selected, the data can be saved for approximately 1500 days. When the internal memory is full, the oldest data will be overwritten.

■ **Analog inputs**

Two settings are possible here.

Menu item	Function
Sensors	If a sensor (e.g. PIKO Sensor) is connected.
Active power control	For the connection of a ripple control receiver.  Detailed description in chapter Self-consumption.  Ch. 7.1



IMPORTANT INFORMATION

The ripple control receiver may only be connected to the master inverter.

Webserver page "Info"

Displays all events and version numbers of the inverter.

■ **Events**

Call up events that have been stored in the inverter. Event messages can be faults or other events. Remedial measures can be found in the "Event codes" chapter  **Ch. 4.10.**

■ **Versions**

Shows information about the versions installed on the inverter. This information can also be viewed without logging into the Webserver.

Function	Meaning
UI	User interface version
FW	Firmware version
HW	Hardware version
PAR	Version of set of parameters
Serial number	Inverter serial number
Article number	Article number of the inverter
Country setting	Shows the inverter's country setting

6. System monitoring



6.1	Creating connection between computer and inverter	94
6.2	The log data	97
6.3	Retrieving, saving and graphically depicting log data	100

6.1 Creating connection between computer and inverter

It is possible to connect the inverter with a computer in the following cases:

- Settings and retrievals in the Webserver.
- Retrieve log data of the inverter.

Inverter and computer can be connected with the following variants:

- **Variant 1**  **Page 95**
Connect inverter and computer
- **Variant 2**  **Page 95**
Connect inverter and computer by way of a switch/
hub/router

Variant 1: Connect inverter and computer

This variant is mainly used for configuring the inverter by way of the Webserver onsite if the inverter is not being integrated in a network. **!**

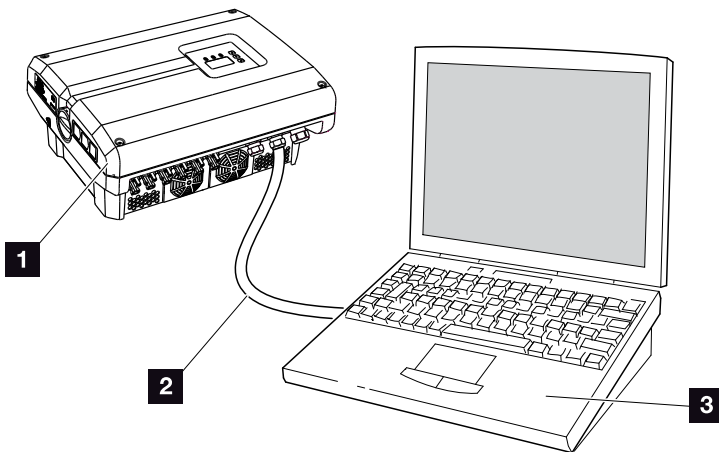

Fig. 49: Connect the inverter and computer directly

- 1** Inverter
- 2** Ethernet cable
- 3** Computer (for configuration or data retrieval)

Variant 2: Connect inverter and computer by way of switch/hub/router

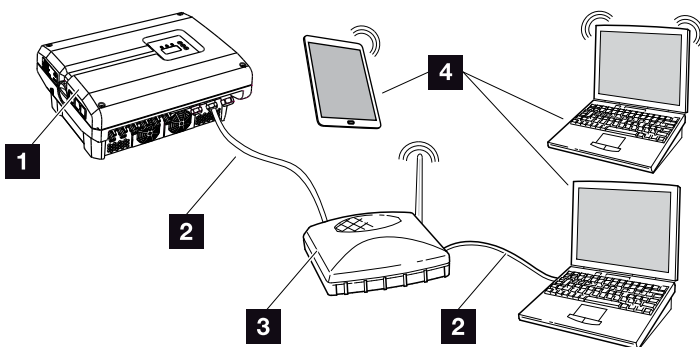

Fig. 50: Connect inverter and computer by way of a router

- 1** Inverter
- 2** Ethernet cable
- 3** Switch/hub/router with or without WLAN
- 4** Computer via LAN or WLAN (for configuration or data retrieval)



IMPORTANT INFORMATION

Use a patch cable of category 6 (Cat 6e) with a maximum length of 100 m.

Manually configuring the network

As the standard default setting, the option "Auto IP/DHCP" and "Router/Gateway" is activated. This means that the inverter obtains its IP address from a DHCP server or automatically generates an IP address and establishes the connection to the Internet through an external router/gateway.



In the following case, the network setting must be entered manually:

- No DHCP server to generate an IP address

A DHCP server can be, for example, an Internet router (cable/DSL). A DHCP server (Dynamic Host Configuration Protocol) is a service that administers and distributes the IP addresses and the network configuration in a network.

If the IP address has to be set manually, this can be done in the inverter menu below or above the Webserver under "Communication".

6.2 The log data

The inverter is equipped with a data logger,  **Tab. 3** which regularly records the following data from the system: 

- Inverter data
- Data from external current sensors
- Grid data
- ENS data

You can find out how to retrieve, save and graphically depict log data in the following chapter  **Ch. 6.3**

The log data can be used for the following purposes:

- Check operating characteristics of the system
- Determine and analyse errors
- Download and graphically depict yield data



INFO

The log data can be downloaded as a DAT or as a TXT file.

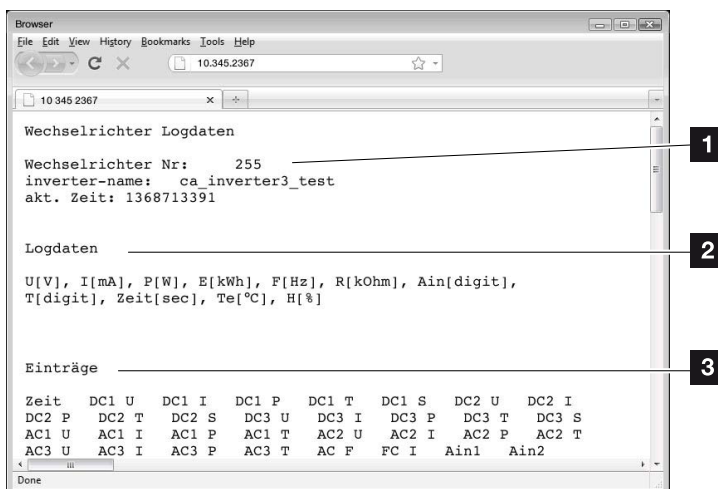



Fig. 51: Example screen "The log file"

- 1** File header
- 2** Physical variables
- 3** Entries in the log file

Log file: File header

The log file contains a file header with information on the inverter:

Entry	Explanation
Inverter number	Number of the inverter
Name	Can be assigned by the user via the browser
Current time	The system time valid at the point in time of file creation in seconds. This makes allocation possible (e.g. 1372170173 Unix time stamp = 25.06.2013 16:22:53) 



INFO

Unix time stamp converter can be found online.

Tab. 6: Log file file header

Log file: Physical variables

The file header is followed by the units of the physical variables. The following table explains the abbreviations for the physical variables:

Entry	Explanation
U	Voltage in volts [V]
I	Current strength in milliamps [mA]
P	Power in watts [W]
E	Energy in kilowatt hours [kWh]
F	Frequency in Hertz [Hz]
R	Resistance in kilohms [kOhm]
T	Counting unit in points [digits]
Aln	Counting unit in points [digits]
Time	Time in seconds [sec] since the inverter was put into operation
TE	Temperature in Celsius [°C]
H	Without function

Tab. 7: Physical variables in the log file

Log file: Entries

The units of the physical variables are followed by various entries in the log file.

The following table explains the various entries of the log file and may deviate depending upon the model:

Entry	Explanation
Time	Time in seconds of the time since the inverter went into operation
DCx U	DC voltage: Input voltage of the respective string (x = 1, 2 and 3) in V
DCx I	DC current: Input current of the respective string (x = 1, 2 and 3) in mA
DCx P	DC power: Input power of the respective string (x = 1, 2 and 3) in W
DCx T	DC temperature: Details for service. Temperature of the respective phase (x = 1, 2 and 3) in digital values
DCx S	DC status: Details for service of the respective string (x = 1, 2 and 3)
ACx U	AC voltage: Output voltage of the respective phase (x = 1, 2 and 3) in V
ACx I	AC current: Output current of the respective phase (x = 1, 2 and 3) in mA
ACx P	AC power: Output power of the respective phase (x = 1, 2 and 3) in W
ACx T	AC temperature: Details for service. Temperature of the respective phase (1, 2 and 3) in digital values
AC F	AC frequency: Grid frequency in Hz
FC I	Residual current: Measured residual current in mA
Aln1 Aln2 Aln3 Aln4	Analog input voltage: Display of the analog inputs 1 to 4 of the communication board. The measured voltage value in V can be calculated with the value from the table (digits) and the following formula: Input voltage [V]=(10/1024) * digits. If the S0 input is used to count the energy pulses, both table columns Aln3 and Aln4 give the sum of the energy pulses per log interval. This total value is calculated as follows: $E_{total} = Aln3 * 2^{16} + Aln4$
AC S	AC status: Details for service of the operational status of the inverter
ERR	General malfunctions
ENS S	Status of the ENS (device for grid monitoring with assigned switching elements): Status of grid monitoring
ENS Err	Malfunctions of the ENS (device for grid monitoring with assigned switching elements)
SHx P	External current sensor power: Power of the respective phase (x = 1, 2 and 3) in W
SCx P	Self-consumption at the respective phase* (x = 1, 2 and 3) in W
HC1 P	Is not used
HC2 P	Home consumption in W from the PV modules
HC3 P	Home consumption in W from the grid
KB S	Internal communication status when switching to AC grid
Total E	Total energy: Total fed-in energy in kWh when switching to AC grid
HOME E	Home consumption: Energy currently used in the household in kWh
Iso R	Insulation resistance in kOhm when switching to AC grid
Event	POR event, "power on reset": Renewed start-up of communication after a loss of AC voltage.

Tab. 8: Log data

6.3 Retrieving, saving and graphically depicting log data

There are several variants for retrieving and permanently saving the log data:

- **Variante 1:** Download the log data with a computer and display it
- **Variante 2:** Transfer log data to a solar portal and display it

Variante 1: Download the log data with a computer and display it

1. In the Webserver, go to the "Log data" page under "Statistics".  **Ch. 5.2**
 2. Save the file *LogDat.dat* on the computer.
 3. Open the file *LogDat.dat* in Excel.
- ✓ The log data are depicted in table form and can be processed further.

Variante 2: Transfer log data to a solar portal and display it

With a solar portal it is possible to monitor the PV system and the performance data via the Internet.

A solar portal has the following functions, which, however, may differ depending upon the portal:

- Graphic depiction of performance data
- Worldwide online access to the portal
- Email notification of errors
- Data export (e.g. Excel file)
- Long-term storage of log data

Prerequisites for data transfer to a solar portal:

- ✓ Inverter has an Internet connection
- ✓ Logged onto a solar portal (e.g. PIKO Solar Portal)
- ✓ Portal code of solar portal (e.g. P3421)
- ✓ Activation of data transfer in the inverter

Activating data transfer to a solar portal via the control panel 

1. Select the "Settings" menu on the control panel of the inverter.
2. Confirm with the "ENTER" key.
3. Use the "UP", "DOWN" and "ENTER" keys to select the "Communication"/"Portal configuration" menu.
4. Enter the portal code of the solar portal in the "Code:" field. The portal code can also be assigned via the Webserver under "Portal configuration". The portal code for the PIKO Solar Portal (www.piko-solar-portal.de) is P3421.

**INFO**

A correctly set-up network connection/Internet connection is a prerequisite for data transfer

It may take as much as 20 minutes following activation (dependent upon the portal) until the data export is visible on the solar portal.

The transfer time may increase if the connection is impaired (e.g. poor wireless connection).

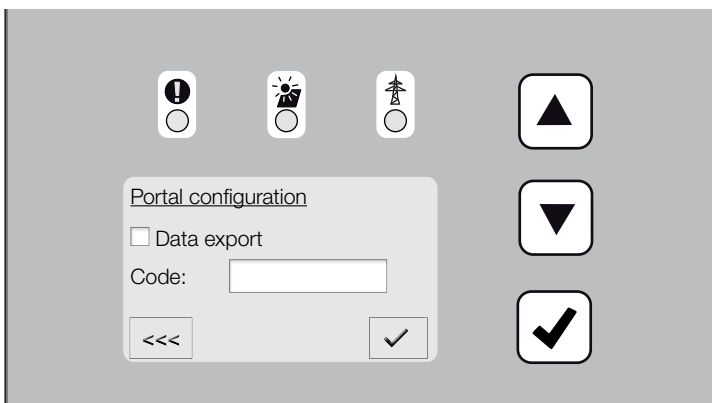

Fig. 52: Entry of the portal code

5. Press and hold down the "ENTER" key for approximately 3 seconds.
 6. Select the "Accept" field and confirm with "ENTER".
- ✓ The data transfer to the solar portal is active (recognisable from the X in front of "Data export"). The name of the solar portal is displayed. The data export to the solar portal is being executed.

7. Active power control

7.1	Why active power control?	104
7.2	Limitation of the PV feed-in capacity	105
7.3	Active power control with a ripple control receiver	106
7.4	Installing the ripple control receiver	107

7.1 Why active power control?

Some countries or energy supply companies stipulate that the full power of the PV system must not be supplied to the public grid (e.g. by limiting it to just 70%).

In this case, some energy supply companies therefore offer the owners of PV systems the possibility of regulating their system with variable active power control, and thus raising the feed-in to up to 100% again.

Ask your energy supply company what application rule applies to you.

The planner of a PV system can choose between two types of active power control: 

- Limitation of the feed-in capacity to a defined percentage of the PV power at the grid connection point
- Active power control with a ripple control receiver by the energy supply company



INFO

When selecting active power control, check to determine which of the two possibilities offers the better energy yield.

7.2 Limitation of the PV feed-in capacity

If the energy supply company stipulates a limitation on PV power for your PV system and you are not able or do not want to implement active power control with a ripple control receiver, then the feed-in capacity should be reduced to the stipulated value by the energy supply company (e.g. 70%).

Ask your energy supply company what power limitation applies to you.

The power limitation is carried out in your inverter with the PARAKO parameterization software. This software is available from Support.

7.3 Active power control with a ripple control receiver

The active power of the PIKO inverter can be controlled directly by the energy supply company via a ripple control signal receiver. **i**

With this technology, the generated power can be regulated at four levels: **!**

- 100 %
- 60 %
- 30 %
- 0 %

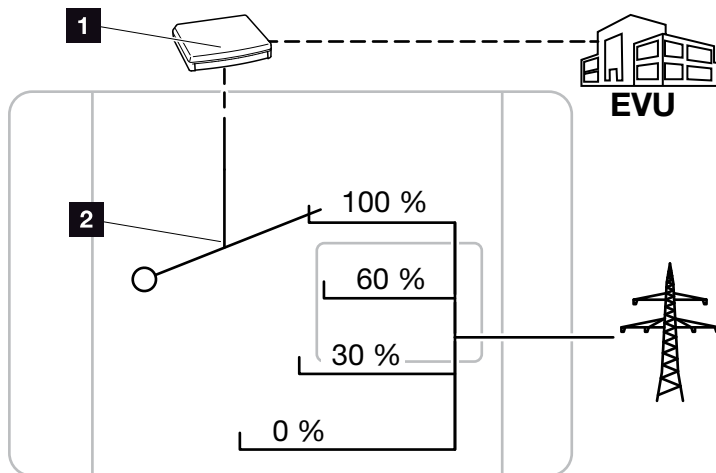

Fig. 53: Active power control with a ripple control receiver

- 1** Ripple control receiver
- 2** Control electronics of the inverter



INFO

For all PIKO inverters, the ripple control signal receiver can be directly connected without an additional device.



INFO

The four standard specifications for the power limitation can be changed using the PARAKO parameterization software. However, the provisions of the energy supply company must be observed.

7.4 Installing the ripple control receiver

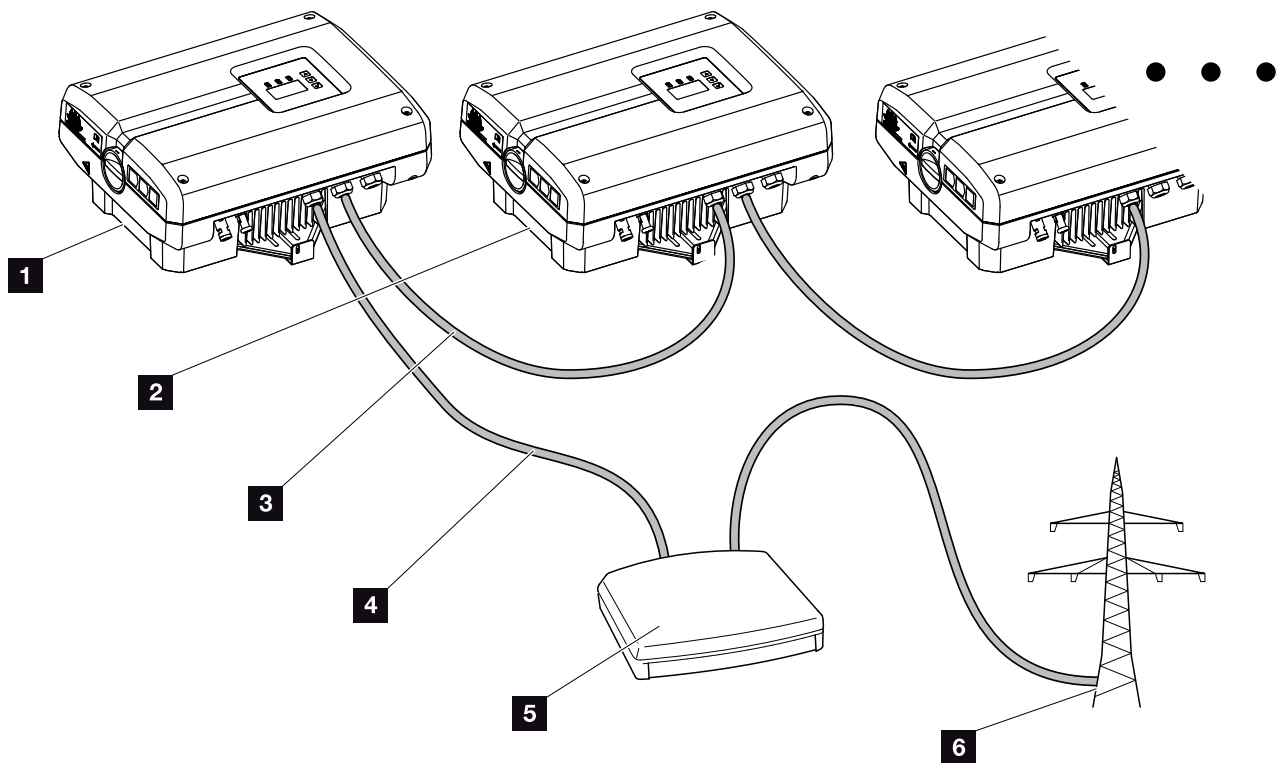

Fig. 54: Configuration of the ripple control receiver with several inverters (Ethernet networking)

- 1 Master inverter
- 2 Additional inverters (slaves)
- 3 Ethernet or RS485 cable
- 4 5-conductor connection
- 5 Ripple control receiver
- 6 Energy supply company

Connecting the ripple control receiver

1. De-energise the inverter.
🔌 Ch. 4.3 ⚠️
2. Connect all inverters via the Ethernet connections (RJ45) with an Ethernet cable or by means of RS485.
🔌 Fig. 54
3. Connect the ripple control receiver to the master inverter 🔌 Fig. 54 It. 1 on the analog interface terminal (10-pin). 🔌 Fig. 55 !

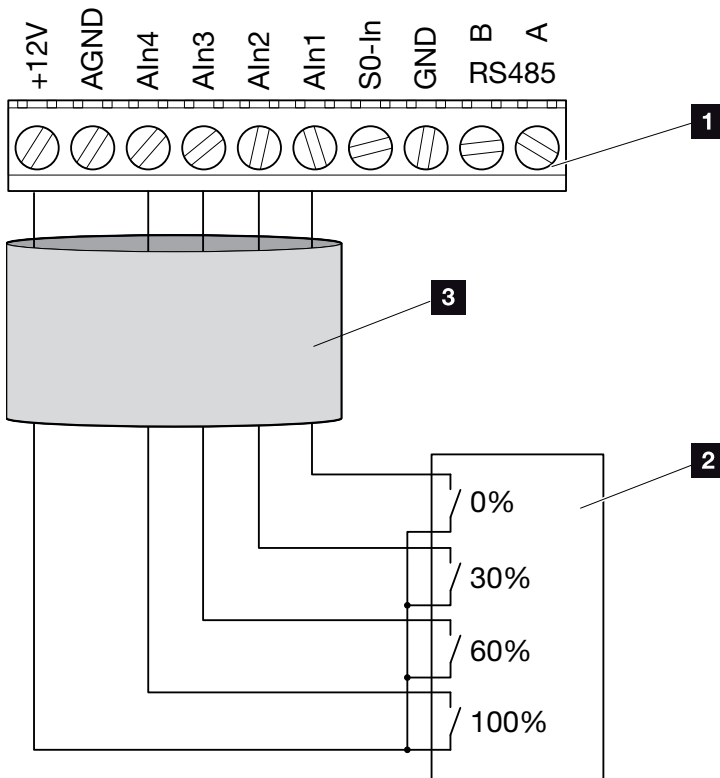

Fig. 55: Connection of ripple control receiver

- 1 Analog interface terminal (10-pin)
 - 2 Ripple control receiver
 - 3 Cable
- ✓ The ripple control receiver is connected.



DANGER

RISK OF DEATH DUE TO ELECTRICAL SHOCK AND DISCHARGE!



De-energise the device, secure it against being restarted and wait five minutes so that the capacitors can discharge. 🔌 Ch. 4.3



IMPORTANT INFORMATION

The ripple control receiver may only be connected at the master inverter. 🔌 Fig. 54

Activating the activepower control function in the Webserver

1. Connect the inverter and computer with an Ethernet cable.  **Ch. 6.1** 
2. Launch an Internet browser.
3. Enter the IP address of the master inverter in the address line of the browser and confirm with "Return". 
- The input screen for the access data opens.
4. Enter your user name and password.
→ The Webserver opens.
5. Select "Settings" > "Analog inputs".
→ "Analog inputs" opens.
6. Select the function "Active power control".
7. Click on the "Accept" button.
- ✓ The active power control for the ripple control receiver is active.



IMPORTANT INFORMATION

The configuration must be carried out on the master inverter to which the ripple control receiver is connected.

No adjustments are necessary on the other inverters.



INFO

The IP address can be queried by way of the control panel in the "Settings" menu.

The IP address is found in the inverter menu under "Settings/Communication/Network settings 2".

Additional entry options in the address line of the browser:
S and the serial number of the inverter on the type plate (example:
<http://S12345FD323456>)





8. Maintenance

8.1	Maintenance and service	111
8.2	Fan cleaning	112
8.3	Update software (communication board)	116
8.4	Update software (inverter firmware)	118
8.5	Update software (country settings)	120
8.6	Replacing optional overvoltage protection	122

8.1 Maintenance and service

Once correctly installed, the inverter runs virtually maintenance-free.

The following maintenance tasks are to be carried out for the inverter:

Activity	Interval
Carry out fan test ¹⁾ and check whether the fans function properly. Clean fans as required  Ch. 8.2 	1x annually or after an incident
Check cable connections and plugs	1x annually
Clean fans  Ch. 8.2 	1x annually

Tab. 9: Maintenance list

If no maintenance work is carried out, this results in an exclusion of the warranty (see 'Exclusion of warranty' in our Service and warranty conditions).

¹⁾ The fan test can only be performed in feed-in mode (green LED lit).



DAMAGE POSSIBLE

Dirty or blocked fans mean that the inverter is not adequately cooled. Insufficient cooling of the inverter may result in output reduction or the failure of the system.

Always mount inverters in such a way that falling parts cannot fall into the inverter through the ventilation grill or mount the optional fan cover.

8.2 Fan cleaning

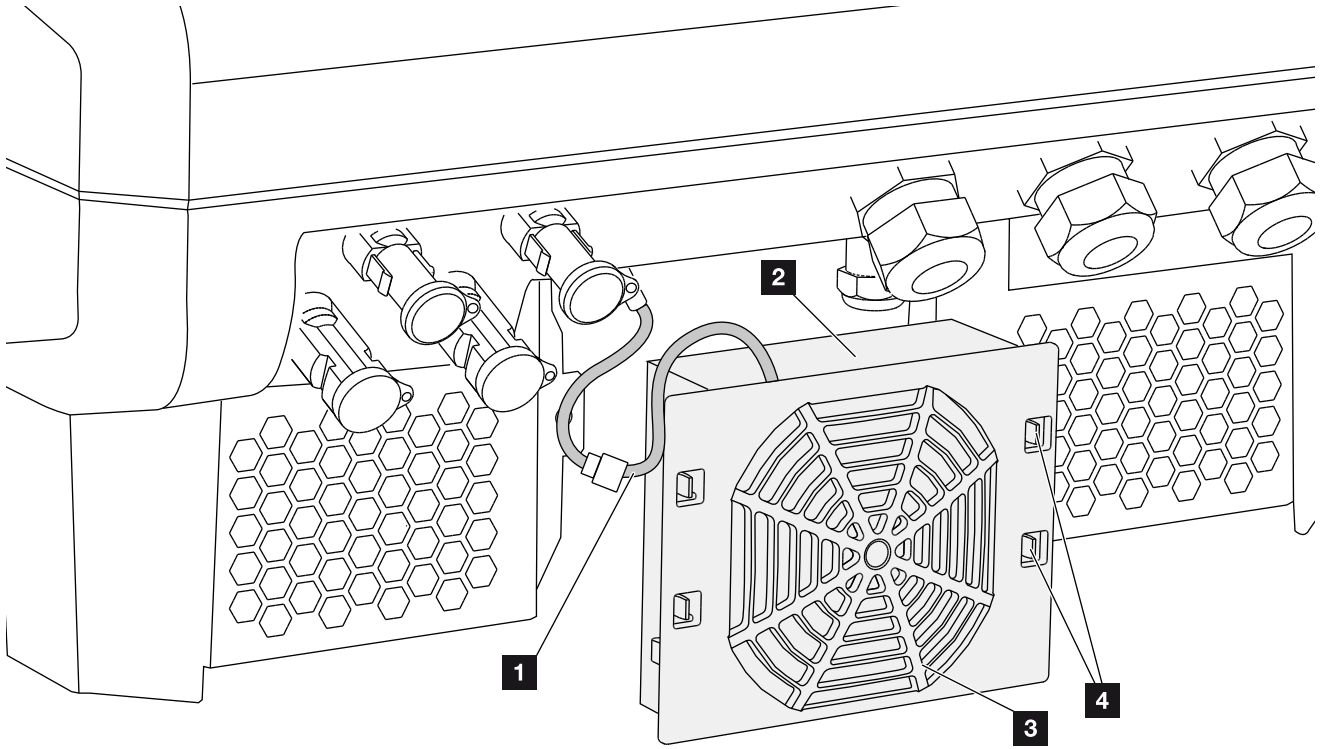

Fig. 56: Fan disassembly overview

- 1** Fan cable
- 2** Fan
- 3** Fan grill
- 4** Fastening straps

Procedure

1. De-energise the inverter ⚠️ ↗️ **Ch. 4.3**
2. Dismantle the fan. To do this, place a screwdriver at the edge of the fan grill and apply a little pressure to the fan grill. ↗️ **Fig. 57**

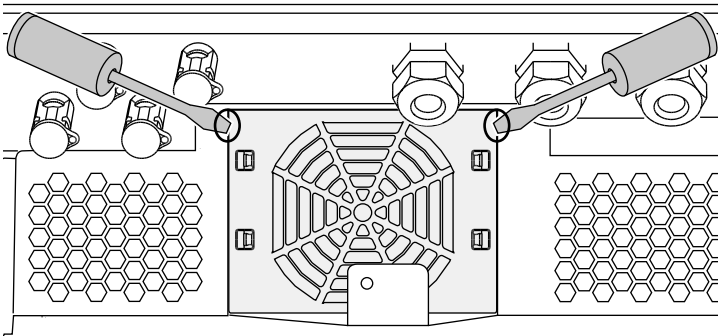

Fig. 57: Loosen fan grill

3. Press the fastening straps toward the centre of the fan with a second screwdriver. Pull the fan unit slightly forward. ↗️ **Fig. 58**

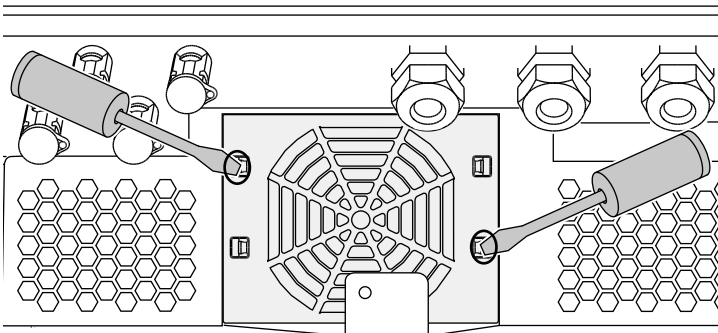

Fig. 58: Loosen fastening straps



DANGER

RISK OF DEATH DUE TO ELECTRICAL SHOCK AND DISCHARGE!

Always de-energise the device during installation and before maintenance and repairs, and secure it against being switched back on.

↗️ **Ch. 4.3 Important!** After de-energising the device, wait five minutes for the capacitors to discharge.

4. Completely remove the fan unit from the housing.
To do this, disconnect the plug of the fan cable.

➤ Fig. 59 !

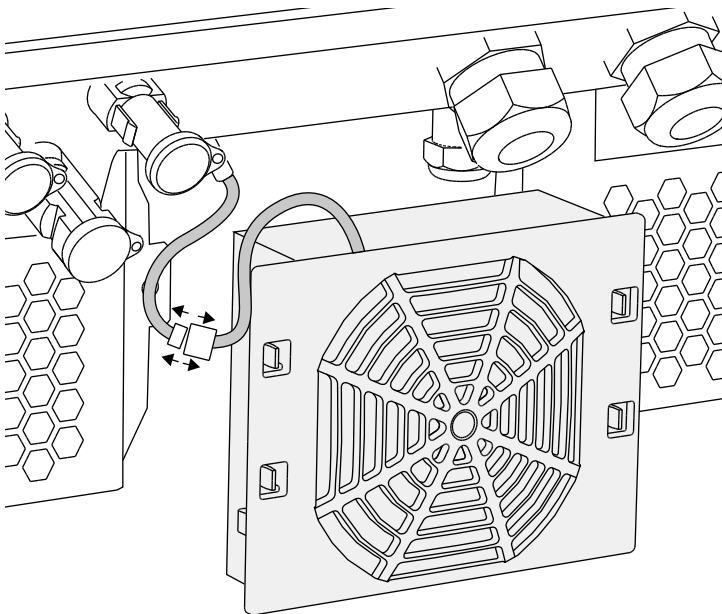

Fig. 59: Pull out fan cable

5. The fan can also be pulled off the fan grill. To do this, press the fastening straps slightly outward and pull off the fan.

➤ Fig. 60

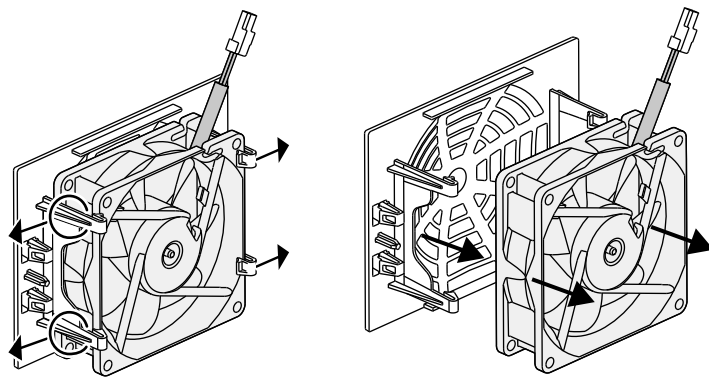

Fig. 60: Disassembly of the fan grill



IMPORTANT INFORMATION

Note the cable guide inside the housing.

When installing the fan, the fan cable must be relaid in exactly the same way.

6. Clean fan and housing opening with a soft brush.
7. Pay attention to the following when installing:
 - The cable must point into the housing.
 - The cable is secured in the device with the cable guides. **!**
 - The cable of the fan must not be crushed.
 - The fan must be correctly installed in the fan frame (air flow direction). **Fig. 61**

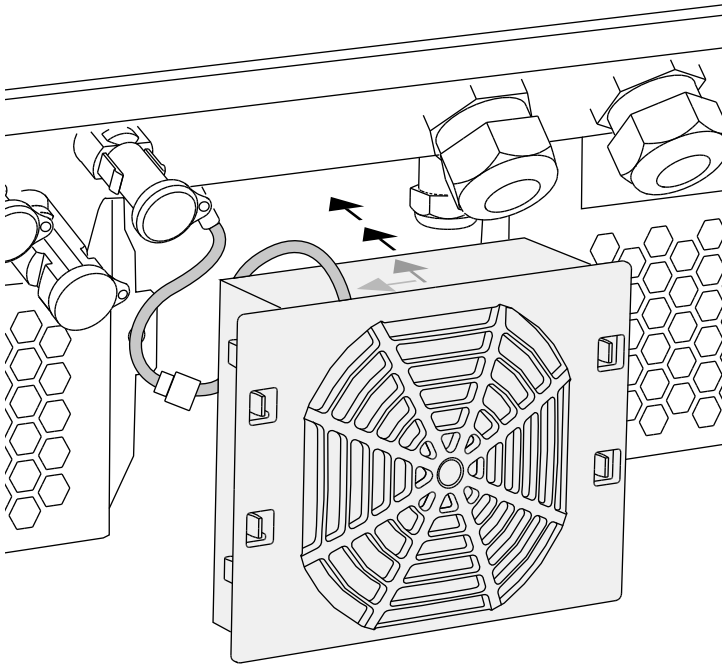

Fig. 61: Fan installation

8. Reconnect the fan cable and insert the fan into the housing. When switching on for the first time, check whether the air from the fan is drawn inwards.
9. Start up the inverter **Ch. 4.1**



IMPORTANT INFORMATION



When installing the fan ensure that the cables are laid and refastened so that they do not run into the fan. If this is not done, the fan may fail or noise may result.

Fasten fan cables with the cable guides intended for this purpose inside the housing.

8.3 Update software (communication board)

When the communication board software is updated by the manufacturer, it can be updated on-site. In the process, the software and the user interface (UI) of the communication board are brought completely up-to-date. If an update is available, you will find this on the manufacturer's website in the download area under Service.

Procedure

1. Download the software update for the communication board from the manufacturer's website.
2. Go to the folder with the downloaded ZIP file.
3. Extract the ZIP file.
→ The files are extracted into a separate folder. In this folder you will find the update and important additional information on the current software update.
4. If the inverter is not yet connected with a PC via LAN, connect this with the inverter now using a LAN cable.   **Ch. 6.1**
5. Start the update by double-clicking on the *.exe file and follow the instructions of the programme on the PC.
→ The update may take up to 10 minutes. Following the update, the message "Update successful" appears on the display of the inverter.



IMPORTANT INFORMATION

The update results in the deletion of the inverter log data. It is therefore advisable to back this up in advance.



DANGER

RISK OF DEATH DUE TO ELECTRICAL SHOCK AND DISCHARGE!

Always de-energise the device during installation and before maintenance and repairs, and secure it against being switched back on.

 **Ch. 4.3 Important!** After de-energising the device, wait five minutes for the capacitors to discharge.

6. If the update was successful, confirm this on the inverter with the "ENTER" key.
If the update was unsuccessful, carry it out again or contact the Service team. 
7. Following successful installation of the software (UI), you can retrieve the current version on the inverter.
Do this by going to:
Settings > Device information > SW/HW release
8. Check the time on the inverter and correct this if necessary.
Do this by going to:
Settings > Basic settings > Date/time.



**INFO**

Following a successful update, the inverter automatically returns to feed-in mode.

8.4 Update software (inverter firmware)

When the inverter firmware is updated by the manufacturer, this can be done on-site. In the process, various hardware controllers are brought entirely up-to-date. If an update is available, you will find this on the manufacturer's website in the download area under Service.

Procedure

1. Download the software update for the inverter from the manufacturer's website.
2. Go to the folder with the downloaded ZIP file.
3. Extract the ZIP file.
 - The files are extracted into a separate folder. In this folder you will find the update and important additional information on the current firmware update.
4. If the inverter is not yet connected with a PC via LAN, connect this with the inverter now using a LAN cable.
 -   **Ch. 6.1**
5. Start the update by double-clicking on the *.exe file and follow the instructions on the PC.
 - The update may take up to 30 minutes. This time is extended if the update is interrupted. Following the update, the message "Update successful" appears on the display of the inverter.



IMPORTANT INFORMATION

In order to carry out the update, enough PV energy for approximately 30 minutes must be available. The update will otherwise be interrupted or even cancelled. For this reason, only carry out the update during the day.



DANGER

RISK OF DEATH DUE TO ELECTRICAL SHOCK AND DISCHARGE!

Always de-energise the device during installation and before maintenance and repairs, and secure it against being switched back on.

 **Ch. 4.3 Important!** After de-energising the device, wait five minutes for the capacitors to discharge.

6. If the update was successful, confirm this on the inverter with the "ENTER" key.
If the update was unsuccessful, carry it out again or contact the Service team. 
7. Following successful installation of the firmware (FW), you can retrieve the current version on the inverter.
Do this by going to:
Settings > Device information > SW/HW release.

**INFO**



Following a successful update, the inverter automatically returns to feed-in mode.

8.5 Update software (country settings)

When the country setting of the inverter is updated by the manufacturer, this can be updated with the "Country Settings Tool". In the process, the country settings and parameters of the country currently set, will be adjusted as necessary.

If an update is available, you will find this on the manufacturer's website in the download area under Service. A password may be needed in various countries in order to activate the new parameters. The password can be acquired from the Service team.

Procedure

1. Download the current "Country Settings Tool" from the manufacturer's website.
 2. Go to the folder with the downloaded ZIP file.
 3. Extract the ZIP file.
- The files are extracted into a separate folder.
4. If the inverter is not yet connected with a PC via LAN, connect this with the inverter now using a LAN cable.
  **Ch. 6.1**
 5. Start the update by double-clicking on the *.exe file and follow the instructions on the PC.
Choose the desired setting in the application and confirm with "Activate". Please note that the country settings must have been set correctly on the inverter in advance.



DANGER

RISK OF DEATH DUE TO ELECTRICAL SHOCK AND DISCHARGE!

Always de-energise the device during installation and before maintenance and repairs, and secure it against being switched back on.

 **Ch. 4.3 Important!** After de-energising the device, wait five minutes for the capacitors to discharge.

6. The inverter will restart when the update has been successful. If the update was unsuccessful, carry it out again or contact the Service team.
- ✓ The update has been carried out.

8.6 Replacing optional overvoltage protection

The overvoltage protection modules can be obtained from your service partner, specialist shops or the KOSTAL Solar Electric GmbH online shop. The types which can be used are listed on the following pages in the Info block.

If overvoltage protection has been inserted in the inverter, recurring or disproportionately high overvoltages may result in accelerated wear and failure of the overvoltage protection used. The function of the overvoltage protection used on the AC and DC sides is therefore monitored by the inverter electronics. The inverter signals the failure of one or more overvoltage protection components with a corresponding event code. 

Depending upon the event code, one or more overvoltage protection modules are affected. Be sure to always replace all modules affected with new ones as quickly as possible. 

Contact your service partner or specialist shop for assistance with this. In order to prevent further damage to the inverter, we recommend decommissioning the inverter until new overvoltage protection has been inserted.



INFO

The function of the overvoltage protection modules of the communication cables cannot be monitored by the inverter electronics.

Problems in communication with the inverter indicate failure of the overvoltage protection modules. If this happens, the modules should be checked.





DAMAGE POSSIBLE

Following notification of an event code indicating defective overvoltage protection, the inverter is no longer protected against external overvoltage.

Should an error occur, all fitted overvoltage protection modules should be replaced with new ones.

Replacing AC/DC overvoltage protection

1. De-energise the inverter  Ch. 4.3 
2. Open the inverter.
3. Replace overvoltage protection on the AC and/or DC side.  The overvoltage protection is coded (by means of a pin on the base and module base) and cannot be inserted the other way round. Note the coding at the plug-in positions.

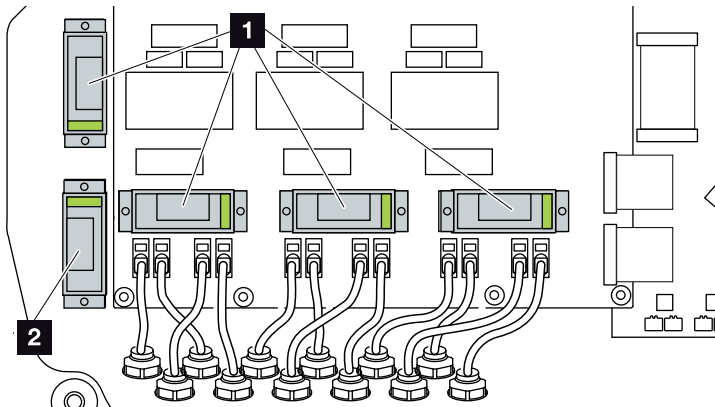

Fig. 62: Installation positions for DC overvoltage protection

-  1 Overvoltage protection for DC side 4 x
-  2 Overvoltage protection for DC side 1 x

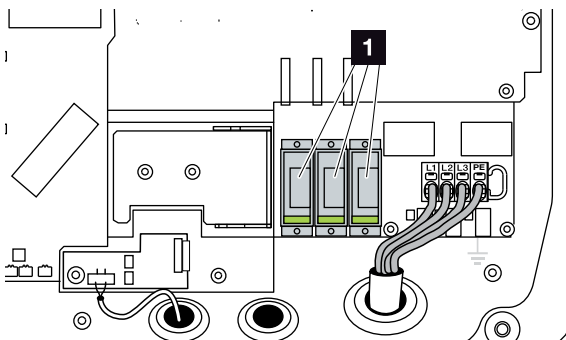



Fig. 63: Installation positions for AC overvoltage protection

-  1 Overvoltage protection for AC side 3 x
- ✓ Overvoltage protection installed



DANGER

RISK OF DEATH DUE TO ELECTRICAL SHOCK AND DISCHARGE!

Always de-energise the device during installation and before maintenance and repairs, and secure it against being switched back on.

 Ch. 4.3 Important! After de-energising the device, wait five minutes for the capacitors to discharge.



INFO

Note the manufacturer's installation and assembly instructions for the overvoltage protection.

The following types are approved for the overvoltage protection and can be ordered from the KOSTAL online shop:

DC side:
 4 x MOD PV SCI 600 DG (10334450)
 1 x MOD PV 600 (10334451)

AC side:
 3 x MOD 275 (10324116)

Defective modules are shown in red in the module's viewing window.

Replacing LAN overvoltage protection

1. Release the cables from the overvoltage protection modules and remove the modules.
2. Insert the new modules into the fitted mount. Plug the communication cables into the corresponding module. **i**

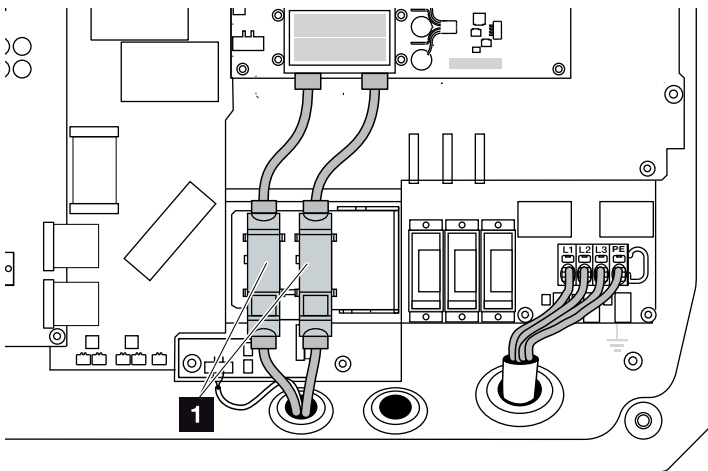

Fig. 64: LAN overvoltage protection

- 1** Installation position for overvoltage protection
Ethernet connections 2 x



INFO

Note the manufacturer's installation and assembly instructions for the overvoltage protection.

The following types are approved for the overvoltage protection and can be ordered from the KOSTAL online shop:

Ethernet connection (LAN):
2 x CLD RJ45B (10324083)

Problems in communication with the inverter indicate defective modules. The inverter does not monitor the modules.

Replacing RS485 overvoltage protection

1. Remove the cables from the RS485 overvoltage protection module.
2. Remove the defective RS485 overvoltage protection module from the communication cables for the RS485.
3. Install the new RS485 overvoltage protection module. Connect the module to the retaining plate intended for this purpose. The module is designed for fastening top-hat rails. Plug the communication cables into the module. **i**

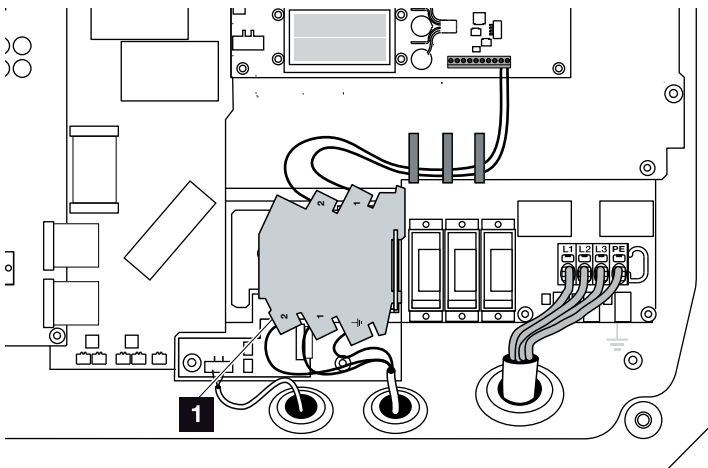

Fig. 65: RS485 overvoltage protection in the inverter

- 1** Installation position for overvoltage protection RS485 connections 1 x
- ✓ Overvoltage protection installed

Closing the inverter

1. Install the cover and screw it tight (5 Nm). **!**
 2. Plug the sockets and plugs of the DC cables onto the inverter.
 3. Switch on the inverter. **🔍 Ch. 4.1**
- ✓ Inverter ready for operation **i**



INFO

Note the manufacturer's installation and assembly instructions for the overvoltage protection.

The following types are approved for the overvoltage protection and can be ordered from the KOSTAL online shop:

RS485 connection:
1 x DCO SD2 ME (RS485) (10330764)

Problems in communication with the inverter indicate a defective module. The inverter does not monitor the module.



IMPORTANT INFORMATION

If incorrectly assembled, the screws securing the cover may seize and destroy the thread inside the housing. Tighten the cover screws crosswise and do not fully tighten them immediately. This will make the cover more centred on the housing and prevent the screws inside the housing from seizing.



INFO

Monitoring of the overvoltage protection modules for AC and DC must be activated in the inverter by going to Overvoltage protection in the Service menu.

9. Technical data

9.1	Technical data	127
9.2	Block diagram	132

9.1 Technical data

Subject to technical changes. Errors excepted.

You can find current information at www.kostal-solar-electric.com.

Inverter	Unit	PIKO 36 EPC
Input side		
Inverter type		PIKO EPC
Max. PV power ($\cos \varphi = 1$)	kWp	40
Rated input voltage ($U_{DC,r}$)	V	580
Max. input voltage (U_{DCmin})	V	580
Max. input voltage (U_{DCmax})	V	1100
Start input voltage ($U_{DCstart}$)	V	580
Min. MPP voltage (U_{MPPmin})	V	580
Max. MPP voltage (U_{MPPmax})	V	800
Max. working voltage ($U_{DCworkmax}$)	V	1000
Max. input current (I_{DCmax}) per DC group (DC1/DC2, DC3/DC4, DC5/DC6)	A	26
Max. PV short-circuit current ($I_{SC,PV}$) per DC group (DC1/DC2, DC3/DC4, DC5/DC6)	A	32.5
Max. PV short-circuit current ($I_{SC,PV}$) per DC input		
Number of DC inputs		6
Number of independent MPP trackers		1

Inverter	Unit	PIKO 36 EPC
Output side		
Rated output, $\cos \varphi = 1$ ($P_{AC,r}$)	kW	36
Max. output apparent power, $\cos \varphi_{adj}$	kVA	36
Max. output voltage (U_{ACmax})	V	460
Min. output voltage (U_{ACmin})	V	320
Rated output current	A	47.6
Max. output current (I_{ACmax})	A	52
Switch-on current (I_{Inrush})	A	1.25
Short-circuit current (peak/RMS)	A	82.4/58.3
Number of feed-in phases		3
Grid connection		3~, 400V
Rated frequency (f_r)	Hz	50
Max. grid frequency (f_{max})	Hz	52
Min. grid frequency (f_{min})	Hz	47.5
Setting range of the power factor $\cos \varphi_{AC,r}$		0.8...1...0.8
Power factor for rated power ($\cos \varphi_{AC,r}$)		1
Max. total harmonic distortion		3
Device properties		
Standby night-time consumption	W	3.7
Efficiency		
Max. efficiency	%	98.7
European efficiency	%	98.3
Californian efficiency	%	98.4
MPP efficiency	%	99.9

Inverter	Unit	PIKO 36 EPC
System data		
Topology: Without galvanic separation - transformerless		✓
Protection class according to IEC 60529		IP 65
Protective class according to IEC 62103		I
Overvoltage category according to IEC 60664-1 input side (PV generator) ¹		II
Overvoltage category according to IEC 60664-1 output side (grid connection) ²		III
DC/AC overvoltage protection		optional type 2
LAN/RS485 overvoltage protection		optional
Degree of contamination ³		4
Environmental category (outdoor installation)		✓
Environmental category (indoor installation)		✓
UV resistance		✓
Min. cable cross-section of AC connection cable ⁵	mm ²	16
Max. cable cross-section of AC connection cable ⁵	mm ²	16
Min. cable cross-section of DC connection cable ⁵	mm ²	4
Max. cable cross-section of DC connection cable ⁵	mm ²	6
Cable cross-section of additional PE connection cable ⁵	mm ²	16
Tightening torque of PE connection, outer	Nm	3
Tightening torque of cover screws	Nm	5
Max. fusing on output side according to IEC 60898-1		B63, C63
Compatibility with external residual current protection devices		RCD type B, RCM type B
Internal operator protection according to EN 62109-2		RCMU/RCCB type B
Automatic switching device integrated (ENS) ⁴		✓
Electronic DC disconnection device integrated		✓
Reverse polarity protection, DC-side		✓

Inverter	Unit	PIKO 36 EPC
Height	mm (inch)	540 (21.26)
Width	mm (inch)	700 (27.56)
Depth	mm (inch)	265 (10.43)
Weight	kg (lb)	51 (112.5)
Cooling principle - regulated fans		✓
Max. air throughput	m ³ /h	299
Max. noise emission	dBA	64
Ambient temperature	°C (°F)	-25...60 (-13...140)
Max. operating altitude above sea level (derating as of 2000 m (6562 ft))	m (ft)	3000 (9843)
Relative humidity (condensing)	%	4...100
Connection technology, DC side		SUNCLIX
Connection technology, AC side		Spring-type terminal strip
Interfaces		
Ethernet RJ45		2
RS485		1
Webserver		✓
Warranty		
Warranty	Years	5
Warranty extension optional	Years	10/20
Directives / Certification		
CE, GS, EN62109-1, EN62109-2, TR3, TR4, TR8, BDEW, VDE-AR-N 4105, NA/EEA, VDE 0126-1-1, CEI 0-16, C10/11, RD661, PO 12.3, G59/3-2, IEC 62116, IEC 61727, EN 50438*, CLC/TS 50549-1, TSE K 191, CLC/TS 50549-2, TSE K 192, TOR D4, ERDF-PRO-RES 64E (*does not apply to all national annexes of EN 50438)		

¹ Overvoltage category II (DC input): The device is suitable for connection to PV strings. Long feed cables out of doors or a lightning protection system in the vicinity of the PV system, may make lightning protection or surge protection equipment necessary.

² Overvoltage category III (AC output): The device is suitable for permanent connection in the grid distribution behind the meter and the line protection fuse. When the connection line travels outdoors over long distances, overvoltage protection devices may be necessary.

³ Contamination degree 4: Contamination results in continuous conductivity, e.g. due to conductive dust, rain or snow; indoors or outdoors.

⁴ Automatic disconnection device to VDE V 0126-1-1, for Austria: The inverter is equipped "With automatic disconnection device in accordance with ÖVE/ÖNORM E 8001-4-712".

⁵ The inverter's terminals are only suitable for copper cables.

9.2 Block diagram

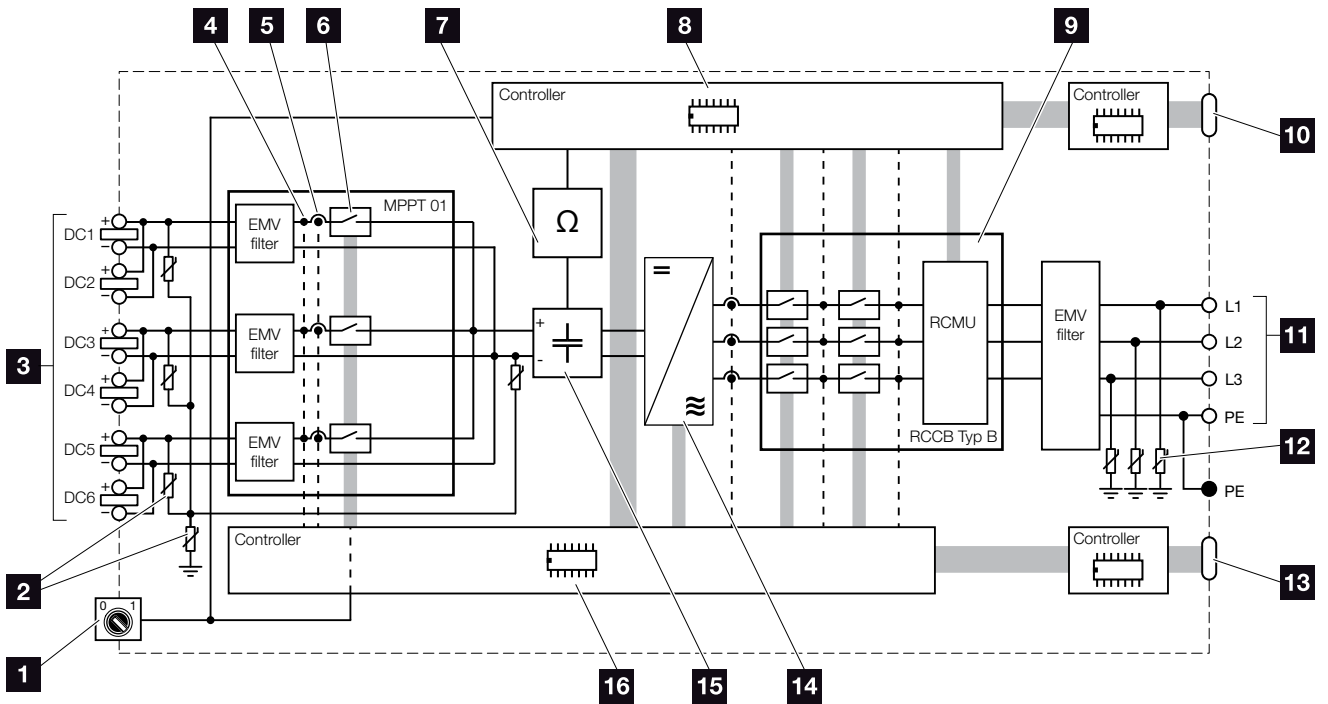
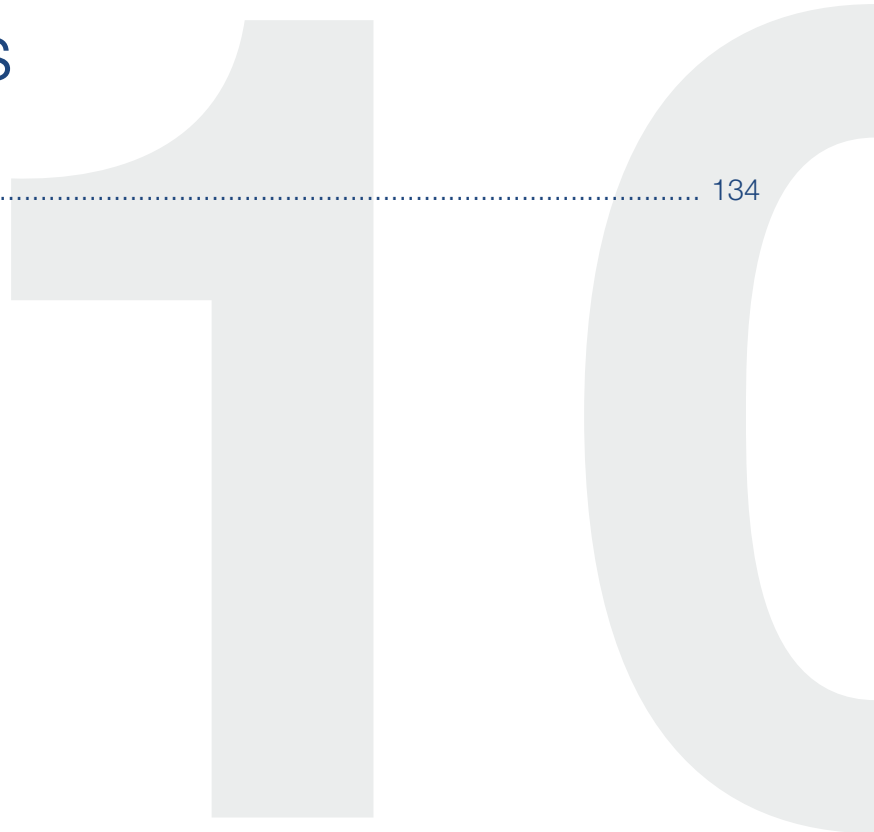

Fig. 66: Block diagram

- 1** DC switch
- 2** Optional DC overvoltage protection
- 3** PV strings
- 4** Voltage measuring point
- 5** Current measuring point
- 6** Electronic DC disconnection device
- 7** Insulation monitoring
- 8** Grid monitoring and shut-down control panel
- 9** Grid monitoring and shut-down
- 10** Central grid and system protection interface (circuit breaker)
- 11** 3-phase AC output
- 12** Optional AC overvoltage protection
- 13** Display and communication
- 14** Inverter bridge
- 15** Intermediate circuit
- 16** System control with MPP trackers

10. Accessories

10.1 Additional accessories	134
-----------------------------------	-----



10.1 Additional accessories

PIKO M2M Service

The PIKO M2M Service allows KOSTAL customers to monitor a PV system using a mobile link to the PIKO Solar Portal for continuous system monitoring.

A secure and encrypted VPN connection which only allows communication between PIKO inverters and the PIKO Solar Portal, protects the user against misuse and excessive costs.

The 5-year package price involves no monthly costs, reducing administration and assuring smooth monitoring for a period of at least five years. Two different packages are available depending on the size of the system.

You can find additional information about this product on our website www.kostal-solar-electric.com under the category Products/Monitoring.

PIKO Solar Portal

The PIKO Solar Portal makes it possible to monitor the operation of the PIKO inverters via the Internet. You can register for the PIKO Solar Portal for no charge on our website.

The portal code for the PIKO Solar Portal (www.piko-solar-portal.de) is P3421.

You can find additional information about this product on our website www.kostal-solar-electric.com under the category Products/Monitoring.

PIKO Solar App

Using the new PIKO Solar App, customers can monitor their systems easily via their smartphone or tablet. Important data relating to the PV system can be queried using the app. For example, you can monitor your DC yield and see how much electricity you're feeding into the public grid.

In addition to this live data, which is updated via WLAN, you can also display past yields, e.g. from yesterday or last week, as a diagram.

You can find additional information about this product on our website www.kostal-solar-electric.com under the category Products / Monitoring - Accessories.

PIKO Sensor

The PIKO Sensor makes it possible to compare the real irradiation and temperature conditions with the performance data of the PV system.

The following values are measured with the PIKO Sensor:

- Irradiation
- Ambient temperature
- Module temperature

A special feature: The measuring values can be visualised via a solar portal (e.g. PIKO Solar Portal).

You can find additional information about this product on our website www.kostal-solar-electric.com under the category Products/Monitoring.

PIKO overvoltage protection modules

In order to protect the inverter from overvoltage damage, type II overvoltage protection can be used on the AC and DC, LAN and RS485 sides.

When supplied, the inverter does not have overvoltage protection.

The overvoltage protection modules can be obtained from our KOSTAL online shop. 

You will find the KOSTAL online shop on our homepage at www.kostal-solar-electric.com.

PIKO fan cover

Falling parts that enter the fan through the inverter's cooling ribs may block the fan and therefore result in the inverter overheating. Insufficient cooling of the inverter can result in a reduction in performance or even system failure.

To protect against falling parts, a specially adapted cover plate can be fitted, which covers the ventilation grill but still ensures inverter cooling.

The cover plate can be obtained from our KOSTAL online shop.

You will find the KOSTAL online shop on our homepage at www.kostal-solar-electric.com.



INFO

The following types are approved for overvoltage protection:

DC side:

4 x MOD PV SCI 600 DG (10334450)

1 x MOD PV 600 (10334451)

AC side:

3 x MOD 275 (10324116)

Ethernet connection (LAN):

2 x CLD RJ45B (10324083)

RS485 connection:

1 x DCO SD2 ME (RS485) (10330764)

11. Appendix

11.1 Type plate	138
11.2 Warranty and service	139
11.3 Handover to the operator	140
11.4 Disassembly and disposal	141

11.1 Type plate

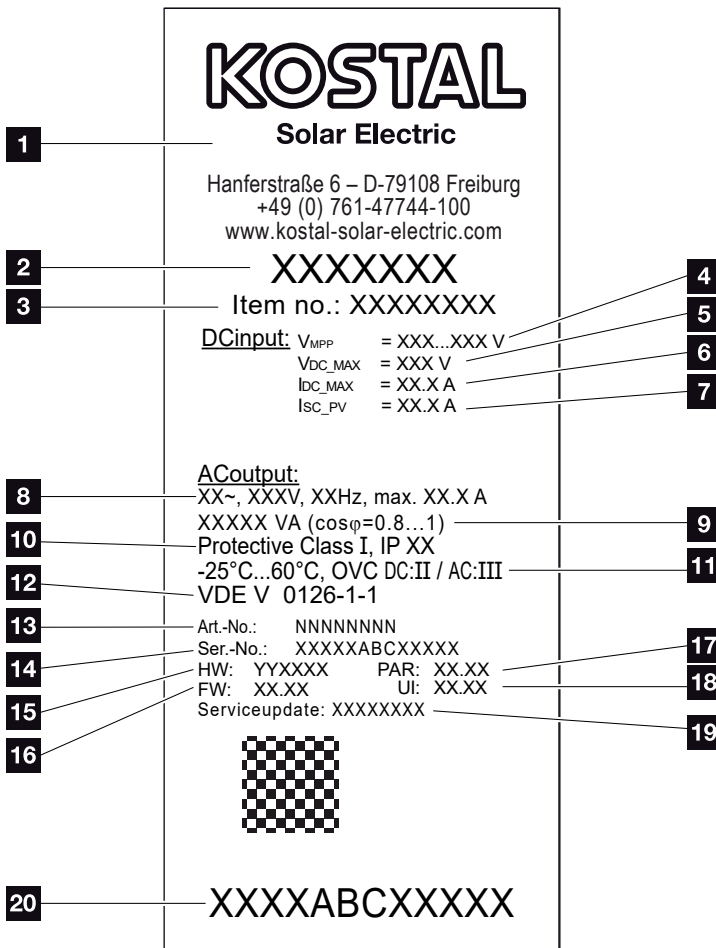

Fig. 67: Type plate

The type plate is located on the right hand side of the inverter. You will find the device type and the most important technical data listed on the type plate.

- 1 Name and address of manufacturer
- 2 Device type
- 3 Article number
- 4 MPP control range
- 5 Maximum DC input voltage
- 6 Maximum DC input current
- 7 Maximum DC short-circuit current
- 8 Number of feed-in phases, output voltage (nominal), grid frequency, maximum AC output current
- 9 Maximum AC output
- 10 Protection class according to IEC 62103, type of protection
- 11 Ambient temperature range, overvoltage category
- 12 Requirements to which the built-in grid monitoring conforms
- 13 Internal article number
- 14 Serial number
- 15 Version number of the hardware
- 16 Version number of the firmware
- 17 Version number of the parameter set
- 18 Version number of the user interface of the device
- 19 Date of last update (only for service devices)
- 20 Removable warranty label

11.2 Warranty and service

- Information about warranty can be found in the separate warranty conditions for the inverter on our homepage.
- For service information and a possible subsequent shipment of parts, we require your device type and the serial number. You will find this information on the type plate on the exterior of the housing.
- If parts are required, use only original replacement parts.

If you have any technical questions, please call our service hotline:

- Germany and other countries¹
+49 (0)761 477 44 - 222
- Switzerland
+41 32 5800 225
- France, Belgium, Luxembourg
+33 16138 4117
- Greece
+30 2310 477 555
- Italy
+39 011 97 82 420
- Spain, Portugal²
+34 961 824 927
- Turkey³
+90 212 803 06 26

¹ Language: German, English

² Language: Spanish, English

³ Language: English, Turkish



11.3 Handover to the operator

Following successful installation and commissioning, all documents are to be handed over to the operator. The operator must be made aware of the following points:

- Position and function of the DC switch
- Position and function of the AC line circuit breaker
- Safety when handling the device
- Appropriate procedure when checking and servicing the unit
- Meaning of the LEDs and the display messages
- Contact person in the event of a fault

11.4 Disassembly and disposal

To disassemble the inverter, proceed as follows:

1. De-energise the inverter.
 **Ch. 4.3** 
2. Open the inverter cover.
3. Loosen terminals and cable glands.
4. Remove all DC and AC lines.
5. Close the inverter cover.
6. Loosen the screw underneath the inverter.
7. Lift the inverter from the wall mount.
8. Dismantle the wall mount.

Proper disposal

Electronic equipment labelled with a dustbin with a line through it, may not be disposed of with household waste. This equipment can be handed in to waste collection points free of charge.



Find out about the local requirements for the separate collection of electrical and electronic equipment in your country.



DANGER

RISK OF DEATH DUE TO ELECTRICAL SHOCK AND DISCHARGE!

De-energise the device, secure it against being restarted and wait five minutes so that the capacitors can discharge.  Ch. 4.3



Index

A

Accessories	133
AC/DC overvoltage protection	41, 123
Active power control	104, 109
Auto IP	65, 89, 96

B

Block diagram	132
---------------------	-----

C

Cable.....	130
Calling up Webserver	80
Certification	130
Communication board	24, 48, 66
Connect computer	79
Control buttons.....	25
Country setting.....	67
Current operating manual	11

D

Data export	65, 100, 101, 102
DC cables	44, 47, 125, 141
DC connections.....	35, 47, 57
DC switch.....	22, 52, 55, 56, 57, 132
DHCP server	89, 96
Directives.....	130
Display	33, 52, 58, 59, 60, 61, 63, 69
Disposal	141



E

EMS	68
Energy management system	68
Ethernet.....	50, 79, 81, 89, 95, 107, 108, 130
Ethernet cable	79, 81, 108, 109
EU declarations of conformity	10
Event codes	69
Event messages	25, 66

F

Factory setting.....	67
Faults	66, 99
Firmware	138

G

Grid monitoring.....	70, 99, 138
----------------------	-------------

H

History.....	84, 135
Hotline.....	7, 139

I

Initial commissioning.....	52
Inputs.....	49, 127
Interfaces.....	49, 130
IP address	65, 78, 80, 89, 96, 109

L

LAN.....	50, 78
Language	2, 65
LAN overvoltage protection	42, 124
Line circuit breaker	35, 52, 55, 57
Log data.....	80, 87, 97, 99, 100



M

Menu.....	26, 52, 59, 63, 64, 65
Modem.....	90

N

Name of the inverter	80
Network settings	109
Notes	11, 13, 16

O

Open the inverter cover	79, 81, 141
Operation	59
Operational statuses.....	25, 61
Overvoltage protection	23, 40, 53, 91, 122

P

Password	80
Plant configuration.....	91
Proper use.....	8
Proxy server	78
PV generator	70, 72, 129

R

Reset web login.....	67
Ripple control receiver	49, 88, 107, 108, 109
RJ45	24, 50, 51, 79, 108, 130
Router	50, 65
RS485.....	49, 51, 65, 89, 107, 130
RS485 overvoltage protection	43, 125



S

SO interface	86
Safety instructions	13
Saving interval	28, 91
Scope of delivery	31
Self-consumption	8, 92, 99
Sensor.....	49, 88, 135
Service code	67
Service menu	67
Settings	25, 26, 28, 58, 63, 65, 78, 80, 81, 88, 94, 101, 109
Solar portal.....	100, 135
Spring-loaded terminal strips	37
Storage	30
Strings.....	46, 52, 55, 56, 99
System protection	38

T

Technical data	127
Terminal.....	36, 49, 108
Transport	30
Type plate.....	69, 80, 109, 138, 139

U

User name.....	80, 109
----------------	---------

W

Wall mount	31, 34, 141
Warnings	14
Warranty.....	9, 45, 130, 139
Webserver	27, 77, 78, 80, 88, 94, 95, 109

KOSTAL

KOSTAL Solar Electric GmbH
Hanferstr. 6
79108 Freiburg i. Br.
Deutschland
Telefon: +49 761 47744 - 100
Fax: +49 761 47744 - 111

KOSTAL Solar Electric Ibérica S.L.
Edificio abm
Ronda Narciso Monturiol y Estarriol, 3
Torre B, despachos 2 y 3
Parque Tecnológico de Valencia
46980 Valencia
España
Teléfono: +34 961 824 - 934

KOSTAL Solar Electric France SARL
11, rue Jacques Cartier
78280 Guyancourt
France
Téléphone: +33 1 61 38 - 4117
Fax: +33 1 61 38 - 3940

KOSTAL Solar Electric Hellas E.Π.Ε.
47 Steliou Kazantzidi st., P.O. Box: 60080
1st building – 2nd entrance
55535, Pilea, Thessaloniki
Ελλάδα
Τηλέφωνο: +30 2310 477 - 550
Φαξ: +30 2310 477 - 551

KOSTAL Solar Electric Italia Srl
Via Genova, 57
10098 Rivoli (TO)
Italia
Telefono: +39 011 97 82 - 420
Fax: +39 011 97 82 - 432

KOSTAL Solar Electric Turkey
Mahmutbey Mah. Taşocağı Yolu
No:3 (B Blok), Ağaoğlu My Office212,
Kat:16, Ofis No: 269
Güneşli-İstanbul
Türkiye
Telefon: +90 212 803 06 24
Faks: +90 212 803 06 25