

**SAMSUNG**

# **EHS**

# **Technical**

# **Data Book**

**EHS Mono HT Quiet for Europe**  
**(R32, 50Hz, HP)**



Model : Outdoor unit (AE\*\*\*BXD\*G/EU)  
Hydro unit (AE\*\*\*RNWM\*G/EU)

# History

---

Version	Modification	Date	Remark
Ver.1.0	Released EHS tank integrated Hydro Unit for Europe TDB (Mono, R32, 50Hz, HP), 1st Version)	22. 04. 08	
Ver.2.0	Released EHS Mono HT Quiet for Europe TDB (R32, 50Hz, HP)	22. 07. 22	
Ver.2.1	Updated the Features&Benefits page and 260L 1 phase hydro unit line up	22. 09. 27	

# Nomenclature

## Model Name

<b>AE</b>	<b>080</b>	<b>B</b>	<b>X</b>	<b>Y</b>	<b>D</b>	<b>E</b>	<b>G</b>	<b>/</b>	<b>EU</b>
(1)	(2)	(3)	(4)	(5)	(6)	(7)	(8)		Buyer

### (1) Classification

<b>AE</b>	EHS
-----------	-----

### (5) Feature 1

<b>E</b>	Split
<b>T</b>	TDM
<b>Y</b>	MONO

### (2) Capacity

X 1/10 kW (3 digits)
----------------------

### (6) Feature 2

<b>D</b>	Deluxe
<b>P</b>	Premium

### (3) Version

<b>R</b>	2019
<b>T</b>	2020
<b>A</b>	2021
<b>B</b>	2022

### (7) Rating Voltage

<b>E</b>	220~240V, 50Hz, 1Φ
<b>G</b>	380~415V, 50Hz, 3Φ

### (4) Product Type

<b>N</b>	Indoor Unit
<b>X</b>	Outdoor Unit

### (8) Mode

<b>G</b>	Heat Pump (R32)
<b>H</b>	Heat Pump (R410A)

# Nomenclature

---

## Model Name

<b>AE</b>	<b>200</b>	<b>R</b>	<b>N</b>	<b>W</b>	<b>M</b>	<b>E</b>	<b>G</b>	<b>/</b>	<b>EU</b>
(1)	(2)	(3)	(4)	(5)	(6)	(7)	(8)		Buyer

### (1) Classification

<b>AE</b>	EHS
-----------	-----

### (5) Product Notation

<b>W</b>	Tank integrated hydro unit
----------	----------------------------

### (2) Capacity

x Liter (3 digits)
--------------------

### (6) Feature

<b>S</b>	Split
<b>M</b>	Mono

### (3) Version

<b>R</b>	2019
<b>T</b>	2020
<b>A</b>	2021
<b>B</b>	2022

### (7) Rating Voltage

<b>E</b>	220~240V, 50Hz, 1Φ
<b>G</b>	380~415V, 50Hz, 3Φ

### (4) Product Type

<b>N</b>	Indoor Unit
<b>X</b>	Outdoor Unit

### (8) Mode

<b>G</b>	Heat Pump (R32)
<b>H</b>	Heat Pump (R410A)

# Features & Benefits

EHS Mono HT Quiet

## Comfort without compromise



### 70°C hot water for all your needs

#### Leaving Water Temperature of up to 70°C\*

Enjoy hot water of up to 70°C\*. With its strengthened parts and an extended Oil Groove, the new Scroll Compressor can compress refrigerant at much higher pressure, while Flash Injection Technology increases the flow of refrigerant. So the compression ratio has increased from 13 to 17\*\*..



\* Leaving water temperature, when the outdoor temperature is between -15°C ~ 43°C. Results may vary depending on the actual usage conditions.

\*\* Compression ratio = Discharge pressure / Suction pressure. Based on internal testing on an EHS Mono HT Quiet outdoor unit, compared to a conventional EHS outdoor unit.

# Features & Benefits

## EHS Mono HT Quiet

### Consistently hot, even at -25°C\*

#### 100% Heating Performance at -25°C\*

Get all of the hot water you need all year round. It delivers a 100% heating performance in temperatures as low as -25°C\*. An enlarged heat exchanger transfers more heat at once. A new Scroll Compressor compresses refrigerant at higher pressure, so it works reliably in the coldest conditions.



\* Based on a leaving water temperature of 55°C. Not available on the 14kW singlephase models.

\*\* Based on Samsung's measurements on an EHS HTLN (AE120BXYDGG/EU) model compared to a conventional outdoor unit (AE120RXYDGG/EU) with the same capacity.

### 35dB(A) quiet operation

#### Low Sound Level

Works quietly using various advanced technologies for noise reduction. A 4-Step Quiet Mode lets you reduce the sound level in steps or keep it as low as 35dB(A)\*. Its Multi-serration Fan is also significantly quieter. And various sound reduction technologies absorb noise and vibration.

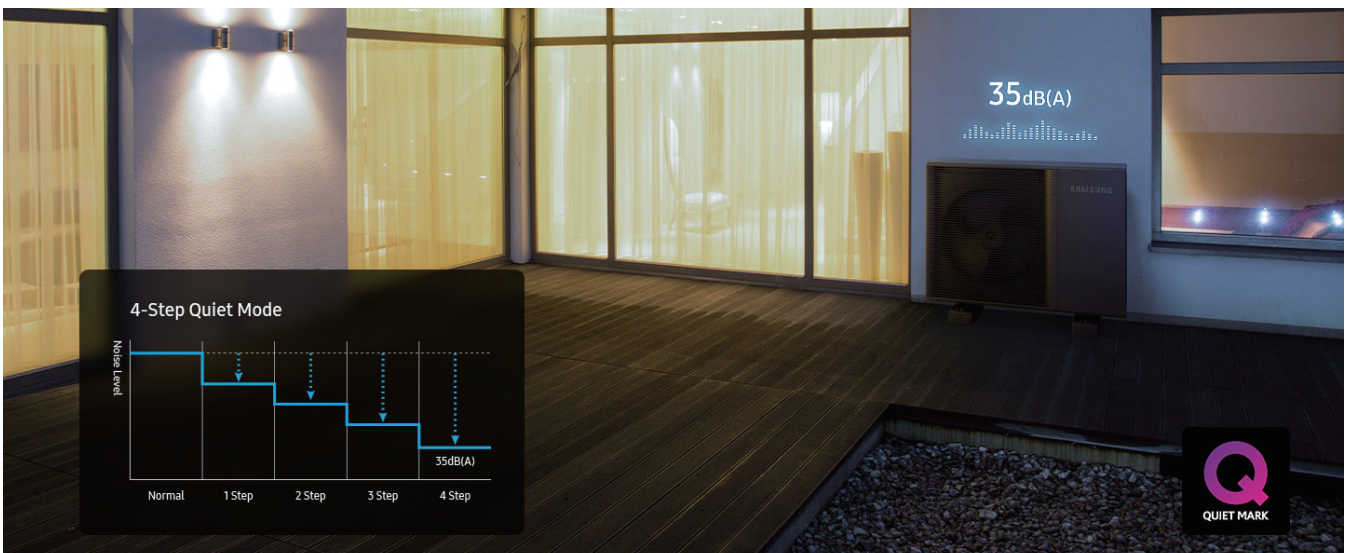

\* Based on internal testing of the EHS Mono HT Quiet outdoor units. The noise level is measured 3m away from the front of the outdoor unit, in an anechoic room with an outside temperature of 7°C. Results may vary depending on environmental factors and individual use.

# Features & Benefits

## EHS Mono HT Quiet

### Prevents freezing to work reliably

#### Reliable Performance in Low Temperatures

Enjoy a reliable performance even at  $-30^{\circ}\text{C}^*$ . The elevated base drains condensed water much faster\*\* and a base heater melts ice. When the unit turns off or malfunctions, the Antifreeze Protection Heater and Antifreeze Protection Control prevent the PHE and water pipe from freezing and bursting\*\*\*.

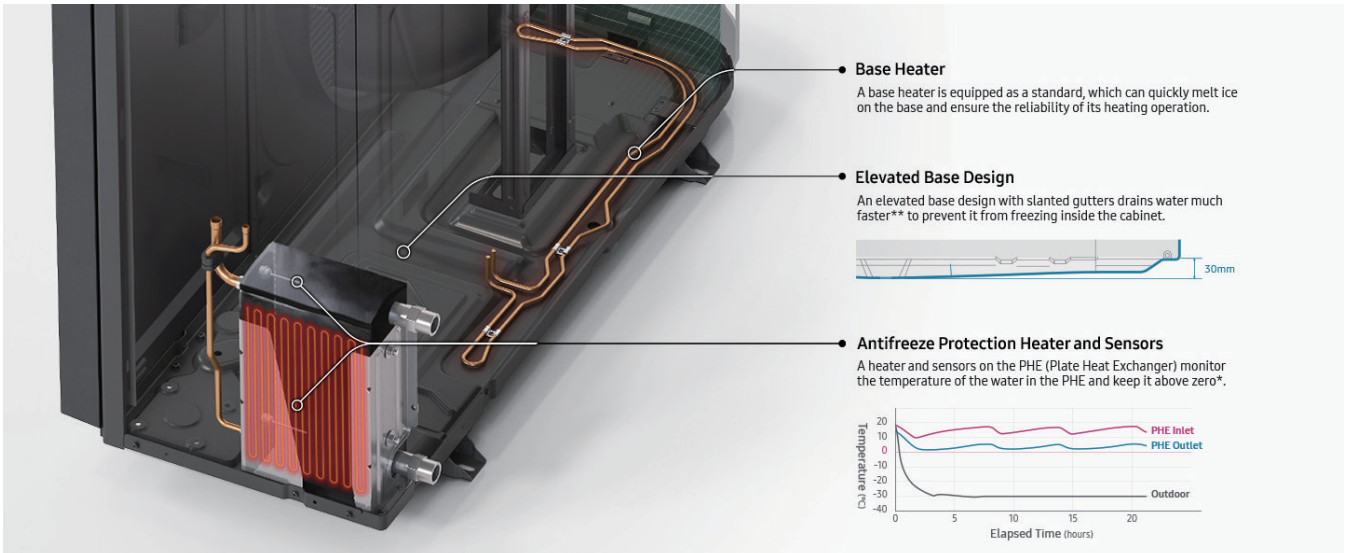

\* Based on internal testing of an EHS Mono HT Quiet AE140BXDYDGG model. Measured for 20 hours when it is not operating and the outdoor temperature is  $-30^{\circ}\text{C}$ .

\*\* Based on internal testing of an EHS Mono HT Quiet outdoor unit compared to a conventional EHS outdoor unit.

\*\*\* For example, if it has stopped operating for 60 minutes when the outdoor temperature is  $3^{\circ}\text{C}$ , the pump on the water pipe side is forcibly operated to prevent the water from freezing in the water pipe.

### Control anywhere

#### Smart Connectivity

Control your heating on the go. Smart Connectivity lets you monitor the temperature of indoor rooms and the leaving water, turn it on/off and adjust the settings anytime and anywhere using the SmartThings App\*. You can also view your energy usage. Or you can simply tell Bixby what you want\*\*.



\* Available on Android and iOS devices. A Wi-Fi connection, Samsung account and an optional Wi-Fi Kit (MIM-H04N) are required.

\*\* Bixby is Samsung's brand of artificial intelligence (AI) / Internet of Things (IoT) voice assistant. A Wi-Fi connection and a Samsung account are required. Bixby only recognizes certain accents and dialects of English (UK), English (US), French (France), German (Germany), Italian (Italy), Korean (South Korea), Mandarin Chinese (China), Spanish (Spain) and Portuguese (Brazil). Other languages to be supported.

\* Amazon, Alexa and all related logos are trademarks of Amazon.com, Inc. or its affiliates. Google is a trademark of Google LLC.

# Contents

---

<b>1. Line-up</b>	<b>9</b>
1-1. Outdoor Units	9
1-2. Tank integrated hydro unit	9
<b>2. Outdoor Units</b>	<b>10</b>
2-1. Specifications	10
2-2. Electrical characteristics	16
2-3. Dimensional drawing	17
2-4. Center of Gravity	18
2-5. Electrical wiring diagram	19
2-6. Sound data	21
2-7. Operation range	26
2-8. Piping diagram	27
2-9. Capacity table	28
2-10. Silent mode corrections	33
<b>3. Tank integrated hydro unit</b>	<b>34</b>
3-1. Specifications	34
3-2. Dimensional drawing	40
3-3. Electrical wiring diagram	42
3-4. Sound data	44
3-5. Piping diagram	49
<b>4. Installation</b>	<b>50</b>
Tank integrated hydro unit	50
Outdoor Unit	59

---



# 1.Line-up

## 1-1. Outdoor Units

Capacity		8.0 kW	12.0 kW	14.0 kW
Image				
Model	1 phase	AE080BXYDEG/EU	AE120BXYDEG/EU	AE140BXYDEG/EU
	3 phase	AE080BXYDGG/EU	AE120BXYDGG/EU	AE140BXYDGG/EU

## 1-2. Tank integrated hydro unit

Type \ Capacity	200 L	260 L
Model	AE200RNWMEG/EU	AE260RNWM*G/EU
Hydro unit		

Model	MIM-E03CN	MIM-E03EN
Control Kit		

## 2. Outdoor Units

### 2-1. Specifications

Model Name		Indoor Unit			AE200RNWMEG/EU	AE200RNWMEG/EU	AE200RNWMEG/EU	
		Outdoor Unit			AE080BXYDEG/EU	AE120BXYDEG/EU	AE140BXYDEG/EU	
Power Supply				Φ, #, V, Hz	1,2,220-240,50	1,2,220-240,50	1,2,220-240,50	
System	Mode				-	Heat Pump (A2W)	Heat Pump (A2W)	Heat Pump (A2W)
Performance	Capacity	Heating	A2W Condition #1. (A7/W30-35)	W	8,000	12,000	14,000	
				Btu/h	27,300	40,900	47,800	
			A2W condition #2. (A7/W40-45)	W	8,000	12,000	14,000	
					8,000	12,000	14,000	
			A2W condition #3. (A7/W47-55)	W	8,000	12,000	14,000	
					8,000	12,000	14,000	
		A-7/W35 <sup>4)*</sup>	W	8,000	12,000	14,000		
				8,000	12,000	14,000		
		Cooling	A2W Condition #1. (A35/W23-18)	W	8,000	12,000	14,000	
					Btu/h	27,300	40,900	47,800
			A2W condition #2. (A35/W12-7)	W	7,500	11,500	12,500	
					7,500	11,500	12,500	
	A2W Condition #1. (A7/W30-35)		W	1,600	2,350	2,770		
				2,051	3,000	3,544		
	A2W condition #2. (A7/W40-45)	W	2,500	3,529	4,179			
			1,818	2,791	3,333			
	A-7/W35 <sup>4)*</sup>	W	2,462	3,810	4,516			
			2,462	3,810	4,516			
	Power	Power Input	Heating	A2W Condition #1. (A7/W30-35)	W	1,600	2,350	2,770
						2,051	3,000	3,544
				A2W condition #2. (A7/W40-45)	W	2,500	3,529	4,179
			1,818			2,791	3,333	
			A-7/W35 <sup>4)*</sup>	W	2,462	3,810	4,516	
					2,462	3,810	4,516	
		Cooling	A2W Condition #1. (A35/W23-18)	W	1,700	2,640	3,140	
					2,273	3,594	3,968	
		Current Input	Heating	A2W Condition #1.	A	7.56	11.12	13.10
8.04						12.46	14.87	
Cooling	A2W condition #2		A	9.69	14.18	16.75		
				10.74	16.98	18.75		
Current	MCA	A	26.0	32.0	32.0			
	MFA	A	28.6	35.2	35.2			
Efficiency	COP (Nominal Heating) A2W condition #1. (A7/W30-35)				5.00	5.11	5.05	
	EER (Nominal Cooling) A2W condition #1. (A35/W23-18)				4.71	4.55	4.46	
	EER (Nominal Cooling) A2W condition #2. (A35/W12-7)				3.30	3.20	3.15	
	COP	A2W condition #2. (A7/W40-45)	W/W	3.90	4.00	3.95		
				3.20	3.40	3.35		
				4.40	4.30	4.20		
				3.25	3.15	3.10		
				3.25	3.15	3.10		
	PdesignH (LWT 35°C)				9,500	12,600	13,600	
	PdesignH (LWT 55°C)				9,500	12,600	13,600	
	SCOP (35°C)				4.64	4.90	4.83	
	SCOP (55°C)				3.38	3.78	3.75	
	SCOP Class (35°C)				A+++	A+++	A+++	
SCOP Class (55°C)				A++	A++	A++		
SEER				4.75	5.00	5.00		
Water Connections	Water Flow Rate (Nominal)	Heating	LPM	23.1	34.6	40.4		
		Cooling	LPM	23.1	34.6	40.4		
	Water Flow Rate	Min	LPM	7	7	7		
		Max	LPM	48	58	58		
	Water Pressure (Max)			bar	3	3	3	
	Water Pipe Type	threaded male	Inlet	Φ, mm	28	28	28	
			Outlet	Φ, mm	28	28	28	
	Leaving Water Temperature	Min.	Heating	°C	15	15	15	
				°C	70	70	70	
		Max.	Cooling	°C	5	5	5	
°C				25	25	25		
Refrigerant	Type			-	R32	R32	R32	
	Factory Charging			kg	2.7	3.3	3.3	
				tCO <sub>2</sub> e	1.82	2.23	2.23	
	Control Method			-	EEV	EEV	EEV	
Outdoor Unit	Compressor	Type			-	Scroll	Scroll	Scroll
		Model Name			-	DS2BB5033FVA	DS2BB5033FVA	DS2BB5033FVA
		Oil	Type	-	POE(Kixx RF P85)	POE(Kixx RF P85)	POE(Kixx RF P85)	
				Initial Charge	cc	1,100	1,100	1,100
		Quantity			EA	1	1	1
		Output			W	3,622	3,622	3,622
		Starting method			-	Inverter driven	Inverter driven	Inverter driven
		Motor	Crankcase heater	Output	W	-	-	-

## 2. Outdoor Units

### 2-1. Specifications

Model Name		Indoor Unit		AE200RNWMEG/EU	AE200RNWMEG/EU	AE200RNWMEG/EU	
		Outdoor Unit		AE080BXYDEG/EU	AE120BXYDEG/EU	AE140BXYDEG/EU	
Outdoor Unit	Heat exchanger	Length		mm	1,224/1,195	1,216/1,187/1,159	1,216/1,187/1,159
		Rows	Quantity	EA	2	3	3
		Fin pitch		mm	1.5	1.5	1.5
		Passes	Quantity	EA	8	11	11
		Face area		m <sup>2</sup>	1.15	1.15	1.15
		Stages	Quantity	EA	46	46	46
		Empty tubeplate hole	Quantity	EA	-	-	-
		Tube type		Φ	7	7	7
		Fin	Type	-	Corrugate	Corrugate	Corrugate
			Treatment	-	Anti Salt	Anti Salt	Anti Salt
	Fan	Type		-	Propeller Fan	Propeller Fan	Propeller Fan
		Discharge direction			Horizontal	Horizontal	Horizontal
		Air Flow Rate	Heating	m <sup>3</sup> /min	92	95	95
			Cooling	m <sup>3</sup> /min	85	90	90
		Quantity		EA	1	1	1
	Fan motor	Quantity		EA	1	1	1
		Model		-	SIC-88FWJ-F1122-1	SIC-88FWJ-F1122-1	SIC-88FWJ-F1122-1
		Output		W	122	122	122
		Drive		-	Direct drive	Direct drive	Direct drive
		Speed	Steps	-	-	-	-
			Heating	rpm	550	590	590
	Cooling		rpm	510	560	580	
	Sound	Sound Pressure	Heating	dB(A)	42	46	47
			Cooling	dB(A)	42	46	47
			Night Mode(3m)	dB(A)	35	35	35
		Sound Power	Heating	dB(A)	56	59	60
			Cooling	dB(A)	56	59	60
	Connections	Water pipe	inlet	Φ, inch	BSPP male 1	BSPP male 1	BSPP male 1
			outlet	Φ, inch	BSPP male 1	BSPP male 1	BSPP male 1
	Casing	Color		-	Shadow Gray	Shadow Gray	Shadow Gray
		Material		-	GI-SGCC	GI-SGCC	GI-SGCC
	Packing	Material		-	EPS/BOX	EPS/BOX	EPS/BOX
		Weight		kg	20.0	20.0	20.0
External Dimension	Net Weight		kg	126.0	137.0	137.0	
	Shipping Weight		kg	146.0	157.0	157.0	
	Net Dimensions(WxHxD)		mm	1,270 x 1,018 x 530	1,270 x 1,018 x 530	1,270 x 1,018 x 530	
	Shipping Dimensions(WxHxD)		mm	1,330 x 1,226 x 630	1,330 x 1,226 x 630	1,330 x 1,226 x 630	
Operating Temp. Range	Heating		°C	-30 ~ 43	-30 ~ 43	-30 ~ 43	
	Cooling		°C	10 ~ 46	10 ~ 46	10 ~ 46	
	D.Hot Water		°C	-30 ~43	-30 ~43	-30 ~43	

#### NOTE

- Specifications may be subject to change without prior notice.
- 1) A2W Condition #1 : (Heating) Water In/Out 30°C/35°C, Outdoor Air 7°C[DB]/6°C[WB];  
(Cooling) Water In/Out 23°C/18°C, Outdoor Air 35°C[DB].
  - 2) A2W Condition #2 : (Heating) Water In/Out 40°C/45°C, Outdoor Air 7°C[DB]/6°C[WB];  
(Cooling) Water In/Out 12°C/7°C, Outdoor Air 35°C[DB].
  - 3) A2W Condition #3 : (Heating) Water In/Out 47°C/55°C, Outdoor Air 7°C[DB]/6°C[WB].
  - 4) A2W Condition : (A2W35) Water In/Out -/35°C, Outdoor Air 2°C[DB]/1°C[WB];  
(A-7/W35) Water In/Out -/35°C, Outdoor Air -7°C[DB]/-(※ Peak Capacity)
  - 5) Select wire size based on the value of MCA
  - 6) Sound pressure level is obtained in an anechoic room.
    - Sound pressure level is a relative value, depending on the distance and acoustic environment.
    - Sound pressure level may differ depending on operation condition.
    - dBA = A-weighted sound pressure level
    - Reference acoustic pressure 0 dB = 20uPa
  - 7) Sound power level is an absolute value that a sound source generates.
    - dBA = A-weighted Sound power level
    - Reference power : 1pW
    - Measured according to ISO 3741
  - 8) These products contain R32 (GWP=675) which is fluorinated greenhouse gas.
  - 9) The system is operated in (-25°C ≤ Outdoor temp. < -20°C) condition, but no guarantee of capacity.
  - 10) The system is operated by only Booster Heater in special condition (35 °C < Outdoor temp. ≤ 43°C).

# 2. Outdoor Units

## 2-1. Specifications

Model Name		Indoor Unit			AE260RNWMEG/EU	AE260RNWMEG/EU	AE260RNWMEG/EU	
		Outdoor Unit			AE080BXYDEG/EU	AE120BXYDEG/EU	AE140BXYDEG/EU	
Power Supply				Φ, #, V, Hz	1,2,220-240,50	1,2,220-240,50	1,2,220-240,50	
System	Mode			-	Heat Pump (A2W)	Heat Pump (A2W)	Heat Pump (A2W)	
Performance	Capacity	Heating	A2W Condition #1. (A7/W35) <sup>1)*</sup>	W	8,000	12,000	14,000	
			Btu/h	27,300	40,900	47,800		
			A2W condition #2	W	8,000	12,000	14,000	
			A2W condition #3	W	8,000	12,000	14,000	
			A2/W35 <sup>4)*</sup>	W	8,000	12,000	14,000	
		A-7/W35 <sup>4)*</sup>	W	8,000	12,000	14,000		
		Cooling	A2W Condition #1. (A35/W23-18) <sup>1)*</sup>	W	8,000	12,000	14,000	
			Btu/h	27,300	40,900	47,800		
			A2W condition #2	W	7,500	11,500	12,500	
			A2W Condition #1. (A7/W35) <sup>1)*</sup>	W	1,600	2,350	2,770	
A2W condition #2	W		2,051	3,000	3,544			
Power	Power Input	Heating	A2W condition #3	W	2,500	3,529	4,179	
			A2/W35 <sup>4)*</sup>	W	1,818	2,791	3,333	
			A-7/W35 <sup>4)*</sup>	W	2,462	3,810	4,516	
			A2W Condition #1. (A7/W35) <sup>1)*</sup>	W	1,700	2,640	3,140	
			A2W condition #2	W	2,273	3,594	3,968	
	Current Input	Heating	A2W Condition #1.	A	7.56	11.12	13.10	
			Cooling	A	8.04	12.46	14.87	
		Heating	A2W condition #2	A	9.69	14.18	16.75	
			Cooling	A	10.74	16.98	18.75	
		Current	MCA	A	26.0	32.0	32.0	
MFA	A	28.6	35.2	35.2				
Efficiency	COP (Nominal Heating) A2W condition #1				5.00	5.11	5.05	
	EER (Nominal Cooling) A2W condition #1				4.71	4.55	4.46	
	EER (Nominal Cooling) A2W condition #2				3.30	3.20	3.15	
	COP		A2W condition #2	W/W	3.90	4.00	3.95	
			A2W condition #3	W/W	3.20	3.40	3.35	
			A2/W35 <sup>4)*</sup>	W/W	4.40	4.30	4.20	
			A-7/W35 <sup>4)*</sup>	W/W	3.25	3.15	3.10	
			PdesignH (LWT 35°C)		9,500	12,600	13,600	
	PdesignH (LWT 55°C)		9,500	12,600	13,600			
	SCOP (35°C)		4.64	4.90	4.83			
	SCOP (55°C)		3.38	3.78	3.75			
	SCOP Class (35°C)		A+++	A+++	A+++			
	SCOP Class (55°C)		A++	A++	A++			
SEER		4.75	5.00	5.00				
Water Connections	Water Flow Rate (Nominal)	Heating	LPM	23.1	34.6	40.4		
		Cooling	LPM	23.1	34.6	40.4		
	Water Flow Rate	Min	LPM	7	7	7		
		Max	LPM	48	58	58		
	Water Pressure (Max)			bar	3	3	3	
	Water Pipe Type	threaded male	Inlet	Φ, mm	28	28	28	
			Outlet	Φ, mm	28	28	28	
	Leaving Water Temperature	Min.	Heating	°C	15	15	15	
				°C	70	70	70	
		Max.	Cooling	°C	5	5	5	
°C				25	25	25		
Refrigerant	Type			-	-	-		
	Factory Charging			kg	2.7	3.3	3.3	
				CO <sub>2</sub> e	1.82	2.23	2.23	
Control Method			-	EEV	EEV	EEV		
Outdoor Unit	Type			-	Scroll	Scroll	Scroll	
	Model Name			-	DS2BB5033FVA	DS2BB5033FVA	DS2BB5033FVA	
	Oil	Type			-	POE(Kixx RF P85)	POE(Kixx RF P85)	POE(Kixx RF P85)
		Initial Charge			cc	1,100	1,100	1,100
	Quantity			EA	1	1	1	
	Output			W	3,622	3,622	3,622	
	Starting method			-	Inverter driven	Inverter driven	Inverter driven	
	Motor	Crankcase heater	Output	W	-	-	-	

## 2. Outdoor Units

### 2-1. Specifications

Model Name		Indoor Unit		AE260RNWMEG/EU	AE260RNWMEG/EU	AE260RNWMEG/EU	
		Outdoor Unit		AE080BXYDEG/EU	AE120BXYDEG/EU	AE140BXYDEG/EU	
Outdoor Unit	Heat exchanger	Length		mm	1224/1195	1216/1187/1159	1216/1187/1159
		Rows	Quantity	EA	2	3	3
		Fin pitch		mm	1.5	1.5	1.5
		Passes	Quantity	EA	8	11	11
		Face area		m <sup>2</sup>	1.15	1.15	1.15
		Stages	Quantity	EA	46	46	46
		Empty tubeplate hole	Quantity	EA	-	-	-
		Tube type		-	Φ7	Φ7	Φ7
	Fin	Type	-	Corrugate	Corrugate	Corrugate	
		Treatment	-	Anti Salt	Anti Salt	Anti Salt	
	Fan	Type		-	Propeller Fan	Propeller Fan	Propeller Fan
		Discharge direction		-	Horizontal	Horizontal	Horizontal
		Air Flow Rate	Heating	m <sup>3</sup> /min	92	95	95
			Cooling	m <sup>3</sup> /min	85	90	90
		Quantity		EA	1	1	1
	Fan motor	Quantity		EA	1EA	1EA	1EA
		Model		-	SIC-88FWJ-F1122-1	SIC-88FWJ-F1122-1	SIC-88FWJ-F1122-1
		Output		W	122W	122W	122W
		Drive		-	Direct drive	Direct drive	Direct drive
		Speed	Steps		-	-	-
			Heating	rpm	550	590	590
	Cooling		rpm	510	560	580	
	Sound	Sound Pressure	Heating	dB(A)	42	46	47
			Cooling	dB(A)	42	46	47
			Night Mode(3m)	dB(A)	35	35	35
		Sound Power	Heating	dB(A)	56	59	60
	Cooling		dB(A)	56	59	60	
Connections	Water pipe	inlet	-	BSPP male 1	BSPP male 1	BSPP male 1	
		outlet	-	BSPP male 1	BSPP male 1	BSPP male 1	
Casing	Color		-	Shadow Gray	Shadow Gray	Shadow Gray	
	Material		-	GI-SGCC	GI-SGCC	GI-SGCC	
Packing	Material		-	EPS/BOX	EPS/BOX	EPS/BOX	
	Weight		kg	20	20	20	
External Dimension	Net Weight		kg	126	137	137	
	Shipping Weight		kg	146	157	157	
	Net Dimensions(WxHxD)		mm	1270 x 1018 x 530	1270 x 1018 x 530	1270 x 1018 x 530	
	Shipping Dimensions(WxHxD)		mm	1330 x 1226 x 630	1330 x 1226 x 630	1330 x 1226 x 630	
Operating Temp. Range	Heating		°C	-30 ~ 43	-30 ~ 43	-30 ~ 43	
	Cooling		°C	10 ~ 46	10 ~ 46	10 ~ 46	
	D.Hot Water		°C	-30 ~ 43	-30 ~ 43	-30 ~ 43	

#### NOTE

• Specifications may be subject to change without prior notice.

1) A2W Condition #1 : (Heating) Water In/Out 30°C/35°C, Outdoor Air 7°C[DB]/6°C[WB]; (Cooling) Water In/Out 23°C/18°C, Outdoor Air 35°C[DB].

2) A2W Condition #2 : (Heating) Water In/Out 40°C/45°C, Outdoor Air 7°C[DB]/6°C[WB]; (Cooling) Water In/Out 12°C/7°C, Outdoor Air 35°C[DB].

3) A2W Condition #3 : (Heating) Water In/Out 47°C/55°C, Outdoor Air 7°C[DB]/6°C[WB].

4) A2W Condition : (A2W35) Water In/Out -/35°C, Outdoor Air 2°C[DB]/1°C[WB]; (A-7/W35) Water In/Out -/35°C, Outdoor Air -7°C[DB]/  
-(※ Peak Capacity)

5) Select wire size based on the value of MCA

6) Soundpressure level is obtained in an anechoic room.

- Sound pressure level is a relative value, depending on the distance and acoustic environment.

- Sound pressure level may differ depending on operation condition.

- dBA = A-weighted sound pressure level

- Reference acoustic pressure 0 dB = 20uPa

7) Sound power level is an absolute value that a sound source generates.

- dBA = A-weighted Sound power level

- Reference power : 1pW

- Measured according to ISO 3741

8) These products contain R32 (GWP=675) which is fluorinated greenhouse gas.

9) The system is operated in (-25°C ≤ Outdoor temp. < -20°C) condition, but no guarantee of capacity.

10) The system is operated by only Booster Heater in special condition (35 °C < Outdoor temp. ≤ 43°C).

# 2. Outdoor Units

## 2-1. Specifications

Model Name		Indoor Unit			AE260RNWMGG/EU	AE260RNWMGG/EU	AE260RNWMGG/EU	
		Outdoor Unit			AE080BXYDGG/EU	AE120BXYDGG/EU	AE140BXYDGG/EU	
Power Supply					Φ, #, V, Hz	3,4,380-415,50	3,4,380-415,50	3,4,380-415,50
System	Mode				-	Heat Pump (A2W)	Heat Pump (A2W)	Heat Pump (A2W)
Performance	Capacity	Heating	A2W Condition #1. (A7/W30-35)	W	8,000	12,000	14,000	
				Btu/h	27,300	40,900	47,800	
			A2W condition #2. (A7/W40-45)	W	8,000	12,000	14,000	
					8,000	12,000	14,000	
			A2W condition #3. (A7/W47-55)	W	8,000	12,000	14,000	
					8,000	12,000	14,000	
		A-7/W35 4)*	W	8,000	12,000	14,000		
				8,000	12,000	14,000		
		Cooling	A2W Condition #1. (A35/W23-18)	W	8,000	12,000	14,000	
				Btu/h	27,300	40,900	47,800	
			A2W condition #2. (A35/W12-7)	W	7,500	11,500	12,500	
					7,500	11,500	12,500	
	A2W Condition #1. (A7/W30-35)		W	1,600	2,350	2,770		
				2,051	3,000	3,544		
	A2W condition #2. (A7/W40-45)	W	2,500	3,529	4,179			
			1,818	2,791	3,333			
	A-7/W35 4)*	W	2,462	3,810	4,516			
			2,462	3,810	4,516			
	Power	Power Input	Heating	A2W Condition #1. (A7/W30-35)	W	1,600	2,350	2,770
						2,051	3,000	3,544
			A2W condition #2. (A7/W40-45)	W	2,500	3,529	4,179	
					1,818	2,791	3,333	
			A-7/W35 4)*	W	2,462	3,810	4,516	
					2,462	3,810	4,516	
		Cooling	A2W Condition #1. (A35/W23-18)	W	1,700	2,640	3,140	
					2,273	3,594	3,968	
		Current Input	Heating	A2W Condition #1.	A	2.51	3.69	4.35
2.67						4.14	4.94	
Cooling			A2W condition #2	A	3.22	4.71	5.56	
					3.92	5.54	6.56	
Current	MCA	A	16.1	16.1	16.1			
	MFA	A	17.7	17.7	17.7			
Efficiency	COP (Nominal Heating) A2W condition #1. (A7/W30-35)				5.00	5.11	5.05	
	EER (Nominal Cooling) A2W condition #1. (A35/W23-18)				4.71	4.55	4.46	
	EER (Nominal Cooling) A2W condition #2. (A35/W12-7)				3.30	3.20	3.15	
	COP	A2W condition #2. (A7/W40-45)	W/W	3.90	4.00	3.95		
				3.20	3.40	3.35		
		A2W condition #3. (A7/W47-55)	W/W	4.40	4.30	4.20		
				3.25	3.15	3.10		
	PdesignH (LWT 35°C)				9,500	12,600	13,600	
	PdesignH (LWT 55°C)				9,500	12,600	13,600	
	SCOP (35°C)				4.64	4.90	4.83	
	SCOP (55°C)				3.38	3.78	3.75	
	SCOP Class (35°C)				A+++	A+++	A+++	
SCOP Class (55°C)				A++	A++	A++		
SEER				4.75	5.00	5.00		
Water Connections	Water Flow Rate (Nominal)	Heating	LPM	23.1	34.6	40.4		
		Cooling	LPM	23.1	34.6	40.4		
	Water Flow Rate	Min	LPM	7	7	7		
		Max	LPM	48	58	58		
	Water Pressure (Max)			bar	3	3	3	
	Water Pipe Type	threaded	Inlet	Φ, mm	28	28	28	
		male	Outlet	Φ, mm	28	28	28	
	Leaving Water Temperature	Min.	Heating	°C	15	15	15	
				°C	70	70	70	
		Max.	Cooling	°C	5	5	5	
				°C	25	25	25	
	Refrigerant	Type			-	R32	R32	R32
Factory Charging			kg	2.7	3.3	3.3		
			tCO <sub>2</sub> e	1.82	2.23	2.23		
Control Method			-	EEV	EEV	EEV		
Outdoor Unit	Compressor	Type			-	Scroll	Scroll	Scroll
		Model Name			-	DS2BB5033FVA	DS2BB5033FVA	DS2BB5033FVA
		Oil	Type	-	POE(Kixx RF P85)	POE(Kixx RF P85)	POE(Kixx RF P85)	
				Initial Charge	cc	1,100	1,100	1,100
		Quantity			EA	1	1	1
		Output			W	3,622	3,622	3,622
		Starting method			-	Inverter driven	Inverter driven	Inverter driven
		Motor	Crankcase heater	Output	W	-	-	-

## 2. Outdoor Units

### 2-1. Specifications

Model Name		Indoor Unit		AE260RNWMGG/EU	AE260RNWMGG/EU	AE260RNWMGG/EU	
		Outdoor Unit		AE080BXYDGG/EU	AE120BXYDGG/EU	AE140BXYDGG/EU	
Outdoor Unit	Heat exchanger	Length		mm	1,224/1,195	1,216/1,187/1,159	1,216/1,187/1,159
		Rows	Quantity	EA	2	3	3
		Fin pitch		mm	1.5	1.5	1.5
		Passes	Quantity	EA	8	11	11
		Face area		m <sup>2</sup>	1.15	1.15	1.15
		Stages	Quantity	EA	46	46	46
		Empty tubeplate hole	Quantity	EA	-	-	-
		Tube type		Φ	7	7	7
		Fin	Type	-	Corrugate	Corrugate	Corrugate
			Treatment	-	Anti Salt	Anti Salt	Anti Salt
	Fan	Type		-	Propeller Fan	Propeller Fan	Propeller Fan
		Discharge direction			Horizontal	Horizontal	Horizontal
		Air Flow Rate	Heating	m <sup>3</sup> /min	92	95	95
			Cooling	m <sup>3</sup> /min	85	90	90
	Quantity		EA	1	1	1	
	Fan motor	Quantity		EA	1	1	1
		Model		-	SIC-88FWJ-F1122-1	SIC-88FWJ-F1122-1	SIC-88FWJ-F1122-1
		Output		W	122	122	122
		Drive		-	Direct drive	Direct drive	Direct drive
		Speed	Steps	-	-	-	-
	Heating		rpm	550	590	590	
	Cooling		rpm	510	560	580	
	Sound	Sound Pressure	Heating	dB(A)	42	46	47
			Cooling	dB(A)	42	46	47
			Night Mode(3m)	dB(A)	35	35	35
		Sound Power	Heating	dB(A)	56	59	60
			Cooling	dB(A)	56	59	60
	Connections	Water pipe	inlet	Φ, inch	BSP male 1	BSP male 1	BSP male 1
			outlet	Φ, inch	BSP male 1	BSP male 1	BSP male 1
	Casing	Color		-	Shadow Gray	Shadow Gray	Shadow Gray
		Material		-	GI-SGCC	GI-SGCC	GI-SGCC
	Packing	Material		-	EPS/BOX	EPS/BOX	EPS/BOX
Weight		kg	20.0	20.0	20.0		
External Dimension	Net Weight		kg	126.0	137.0	137.0	
	Shipping Weight		kg	146.0	157.0	157.0	
	Net Dimensions(WxHxD)		mm	1,270 x 1,018 x 530	1,270 x 1,018 x 530	1,270 x 1,018 x 530	
	Shipping Dimensions(WxHxD)		mm	1,330 x 1,226 x 630	1,330 x 1,226 x 630	1,330 x 1,226 x 630	
Operating Temp. Range	Heating		°C	-30 ~ 43	-30 ~ 43	-30 ~ 43	
	Cooling		°C	10 ~ 46	10 ~ 46	10 ~ 46	
	D.Hot Water		°C	-30 ~ 43	-30 ~ 43	-30 ~ 43	

#### NOTE

- Specifications may be subject to change without prior notice.
- 1) A2W Condition #1 : (Heating) Water In/Out 30°C/35°C, Outdoor Air 7°C[DB]/6°C[WB];  
(Cooling) Water In/Out 23°C/18°C, Outdoor Air 35°C[DB].
  - 2) A2W Condition #2 : (Heating) Water In/Out 40°C/45°C, Outdoor Air 7°C[DB]/6°C[WB];  
(Cooling) Water In/Out 12°C/7°C, Outdoor Air 35°C[DB].
  - 3) A2W Condition #3 : (Heating) Water In/Out 47°C/55°C, Outdoor Air 7°C[DB]/6°C[WB].
  - 4) A2W Condition : (A2W35) Water In/Out -/35°C, Outdoor Air 2°C[DB]/1°C[WB];  
(A-7/W35) Water In/Out -/35°C, Outdoor Air -7°C[DB]/-(× Peak Capacity)
  - 5) Select wire size based on the value of MCA
  - 6) Soundpressure level is obtained in an anechoic room.
    - Sound pressure level is a relative value, depending on the distance and acoustic environment.
    - Sound pressure level may differ depending on operation condition.
    - dBA = A-weighted sound pressure level
    - Reference acoustic pressure 0 dB = 20uPa
  - 7) Sound power level is an absolute value that a sound source generates.
    - dBA = A-weighted Sound power level
    - Reference power : 1pW
    - Measured according to ISO 3741
  - 8) These products contain R32 (GWP=675) which is fluorinated greenhouse gas.
  - 9) The system is operated in (-25°C ≤ Outdoor temp. < -20°C) condition, but no guarantee of capacity.
  - 10) The system is operated by only Booster Heater in special condition (35 °C < Outdoor temp. ≤ 43°C).

## 2. Outdoor Units

### 2-2. Electrical characteristics

Capacity [kW]	Model	Power Supply				Voltage Range [V]		Nominal Running Current [A]		Current [A]	
		Φ	#	Hz	Voltage	Min. (-10%)	Max. (+10%)	Cooling	Heating	MCA	MFA
8.0	AE080BXYDEG/EU	1	2	50	220-240	198	264	7.56	8.04	26.0	28.6
12.0	AE120BXYDEG/EU	1	2	50	220-240	198	264	11.12	12.46	32.0	35.2
14.0	AE140BXYDEG/EU	1	2	50	220-240	198	264	13.10	14.87	32.0	35.2
8.0	AE080BXYDGG/EU	3	4	50	380-415	342	457	2.51	2.67	16.1	17.7
12.0	AE120BXYDGG/EU	3	4	50	380-415	342	457	3.69	4.14	16.1	17.7
14.0	AE140BXYDGG/EU	3	4	50	380-415	342	457	4.35	4.94	16.1	17.7

#### NOTE

- MCA : Minimum circuit amperes
- MFA : Maximum fuse amperes
- Select wire size based on the value of MCA



## 2. Outdoor Units

### 2-3. Dimensional drawing

Units : mm [inches]

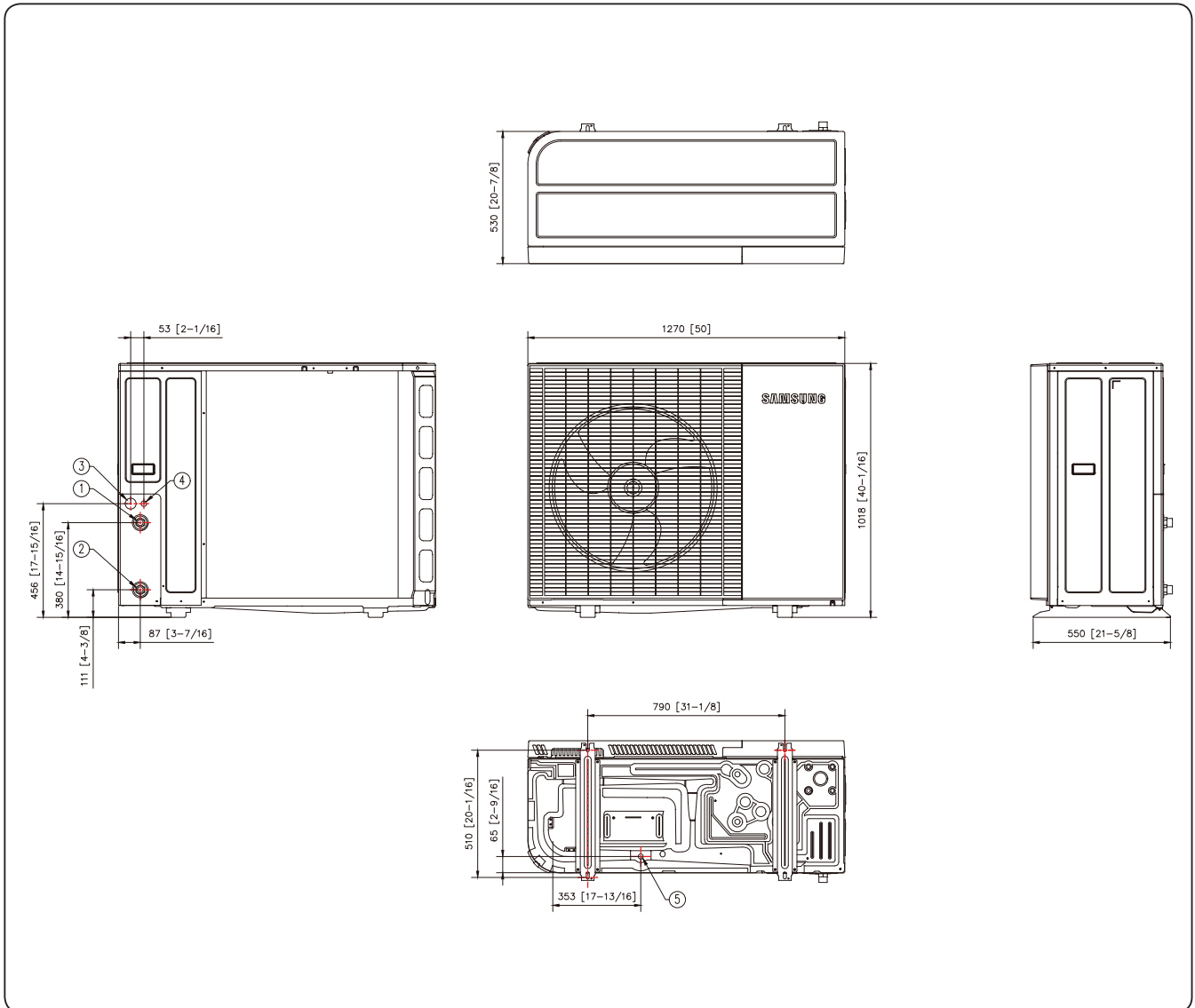

NO	Name	Description
1	Water Pipe(Out)	Φ28
2	Water Pipe(In)	Φ28
3	Power wiring conduit	Φ44
4	communication wiring conduit	Φ22
5	Drain holes	connect with the provided drain plug

## 2. Outdoor Units

### 2-4. Center of Gravity

Units : mm [inches]

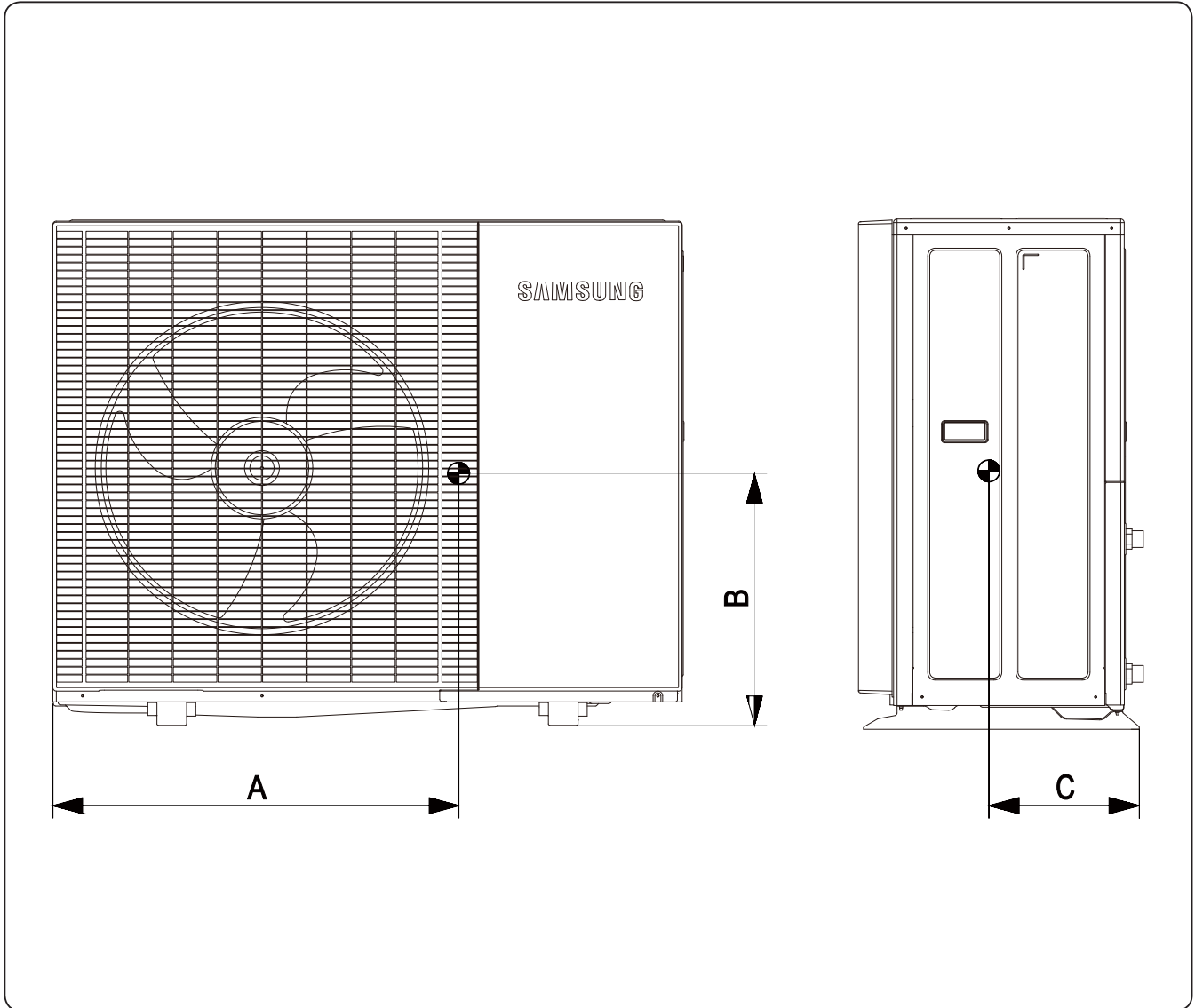

Model	A	B	C
AE*****	800 [31-1/2]	214 [8-7/16]	361 [14-3/16]

# 2. Outdoor Units

## 2-5. Electrical wiring diagram

### AE080/120/140BXYDEG/EU

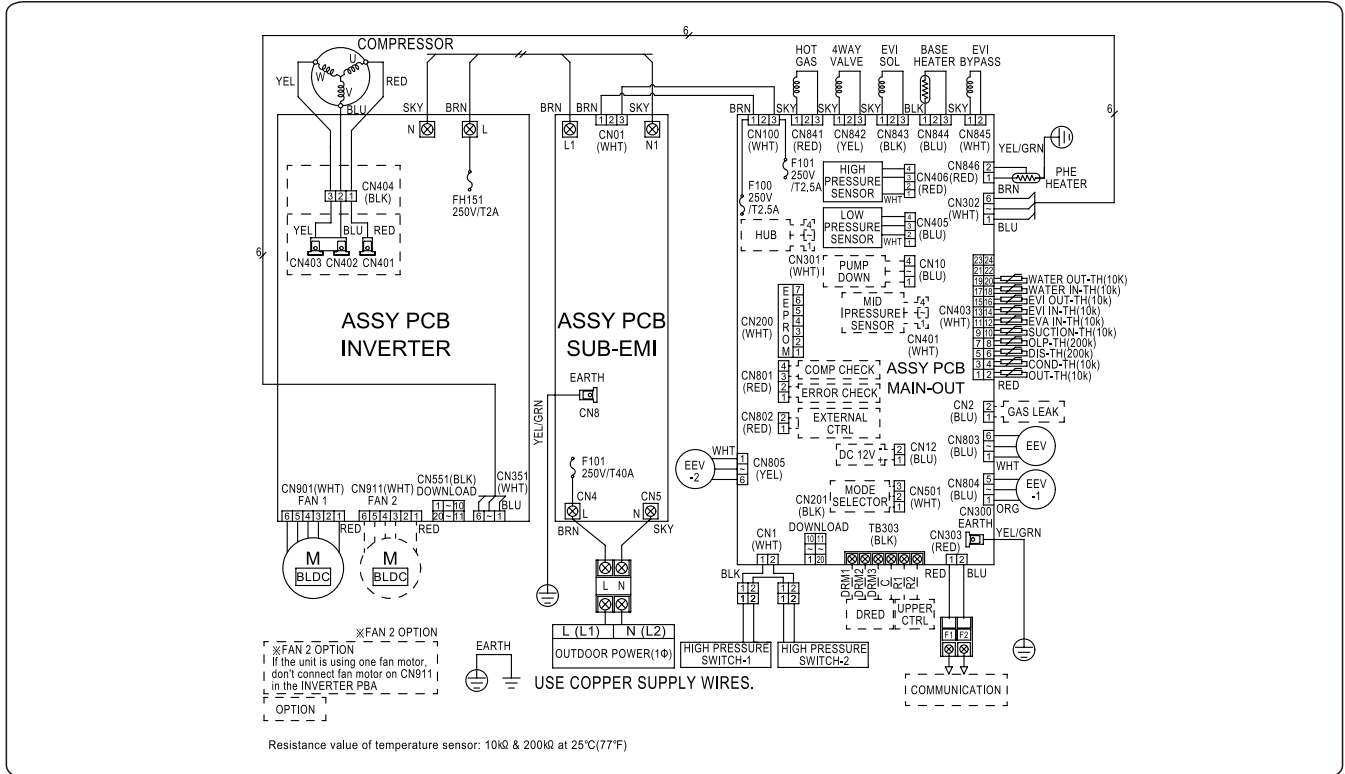

ASSY PCB MAIN-OUT	Printed circuit board(MAIN)	ASSY PCB INVERTER	Printed circuit board(INVERTER)	ASSY PCB SUB-EMI	Printed circuit board(EMI)
250V T40A	FUSE	250V T2.5A	FUSE	250V T2A	FUSE
M(BLDC)	Outdoor Fan	EEV	Electronic Expansion Valve - Main	EEV-1	Electronic Expansion Valve - EVI
EEV-2	Electronic Expansion Valve - Shut off	OUT-TH	Thermistor - Ambient	COND-TH	Thermistor - COND. Out
DIS-TH	Thermistor - Discharge pipe	OLP-TH	Thermistor - Compressor Top	SUCTION-TH	Thermistor - Suction pipe
EVA IN-TH	Thermistor - HEAT Exchanger In	EVI IN-TH	Thermistor - EVI In	EVI OUT-TH	Thermistor - EVI Out
WATER IN-TH	Thermistor - Water In	WATER OUT-TH	Thermistor - Water Out	4WAY VALVE	Solenoid valve - 4Way
EVI BYPASS	Solenoid valve - EVI Bypass	HOT GAS	Solenoid valve - Hot Gas Bypass	EVI SOL	Solenoid valve - Liquid Bypass

### NOTES

1. This wiring diagram applies only to the Outdoor unit.
2. Symbols show as follow :  
BLK: black, RED: red, BLU: blue, WHT: white, YEL: yellow, BRN: brown, SKY: skyblue, GRN: green
3. For connection wiring indoor-outdoor transmission F1-F2.
4. ⚡ Protective earth(SCREW)

# 2. Outdoor Units

## 2-5. Electrical wiring diagram

### AE080/120/140BXYDGG/EU

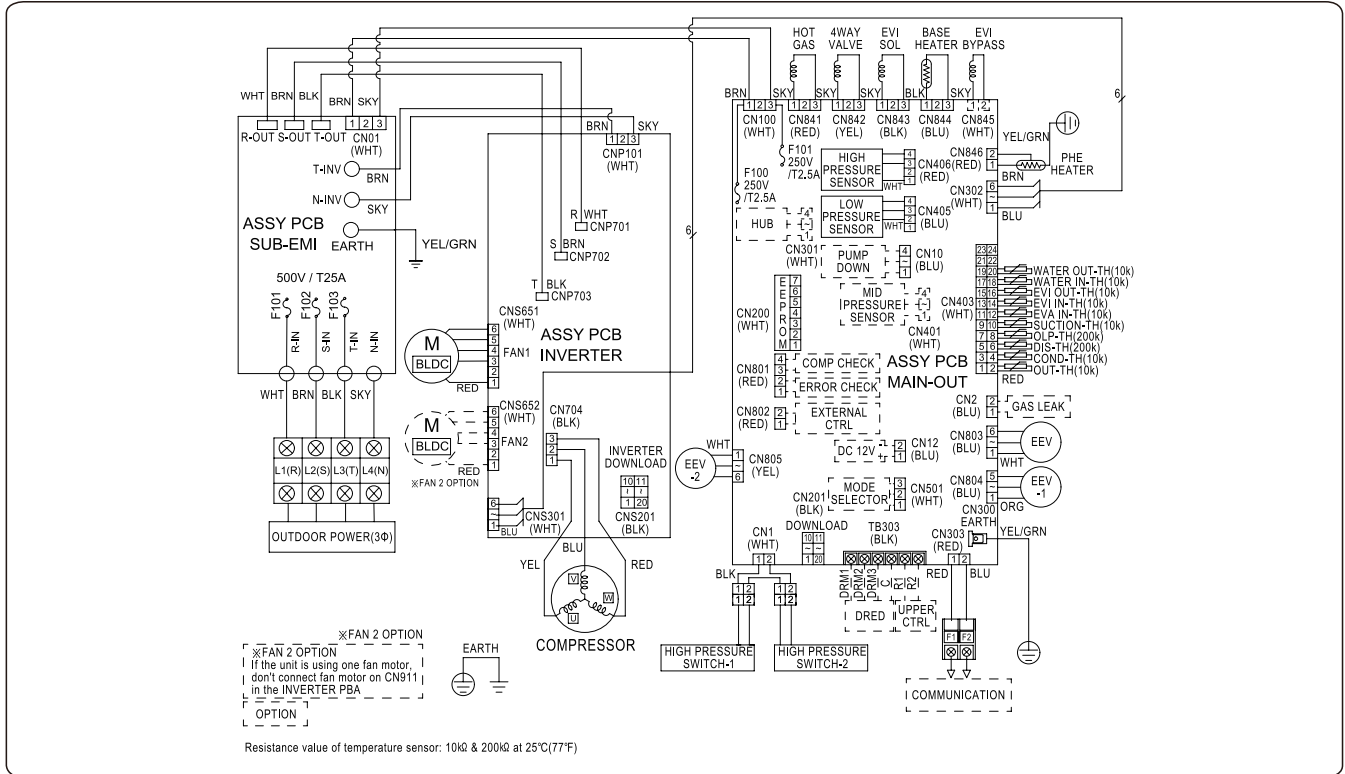

ASSY PCB MAIN-OUT	Printed circuit board(MAIN)	ASSY PCB INVERTER	Printed circuit board(INVERTER)	ASSY PCB SUB-EMI	Printed circuit board(EMI)
250V T40A	FUSE	250V T2.5A	FUSE		
M(BLDC)	Outdoor Fan	EEV	Electronic Expansion Valve - Main	EEV-1	Electronic Expansion Valve - EVI
EEV-2	Electronic Expansion Valve - Shut off	OUT-TH	Thermistor - Ambient	COND-TH	Thermistor - COND. Out
DIS-TH	Thermistor - Discharge pipe	OLP-TH	Thermistor - Compressor Top	SUCTION-TH	Thermistor - Suction pipe
EVA IN-TH	Thermistor - HEAT Exchanger In	EVI IN-TH	Thermistor - EVI In	EVI OUT-TH	Thermistor - EVI Out
WATER IN-TH	Thermistor - Water In	WATER OUT-TH	Thermistor - Water Out	4WAY VALVE	Solenoid valve - 4Way
EVI BYPASS	Solenoid valve - EVI Bypass	HOT GAS	Solenoid valve - Hot Gas Bypass	EVI SOL	Solenoid valve - Liquid Bypass

### NOTES

1. This wiring diagram applies only to the Outdoor unit.
2. Symbols show as follow :  
BLK: black, RED: red, BLU: blue, WHT: white, YEL: yellow, BRN: brown, SKY: skyblue, GRN: green
3. For connection wiring indoor-outdoor transmission F1-F2.
4. Protective earth(SCREW)

## 2. Outdoor Units

---

### 2-6. Sound data

---

#### Summary

Capacity (kW)	Model	Sound Pressure dB(A)		Sound Power dB(A)
		Cooling	Heating	Heating
8.0	AE080BXYDEG/EU	42	42	56
12.0	AE120BXYDEG/EU	46	46	59
14.0	AE140BXYDEG/EU	47	47	60
8.0	AE080BXYDGG/EU	42	42	56
12.0	AE120BXYDGG/EU	46	46	59
14.0	AE140BXYDGG/EU	47	47	60

#### NOTE

- Specifications may be subject to change without prior notice.
- Sound Pressure Level
  - Sound pressure level is obtained in an anechoic room.
  - Sound pressure level is a relative value, depending on the distance and acoustic environment.
  - Sound pressure level may differ depending on operation condition.
  - dBA = A-weighted sound pressure level
  - Reference acoustic pressure 0 dB = 20μPa
- Sound Power Level
  - Sound power level is an absolute value that a sound source generates.
  - dBA = A-weighted sound power level.
  - Reference power : 1pW.
  - Measured according to ISO 3741.

# 2. Outdoor Units

## 2-6. Sound data

### Sound Pressure level

Unit: dB(A)

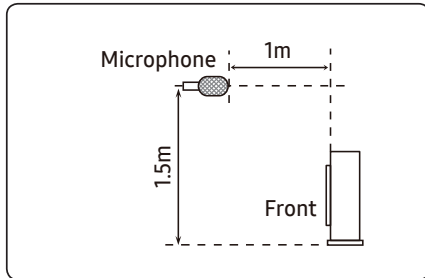

Model	Cooling	Heating
AE080BXYDEG/EU	42	42
AE120BXYDEG/EU	46	46
AE140BXYDEG/EU	47	47

- NR Curve

1) AE080BXYDEG/EU

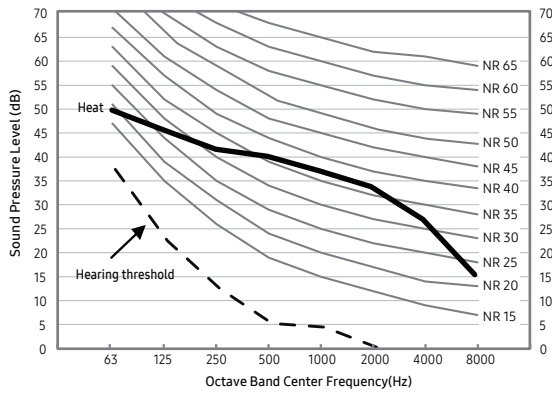

2) AE120BXYDEG/EU

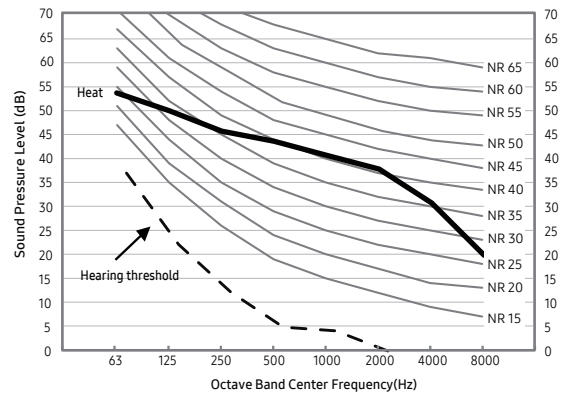

3) AE140BXYDEG/EU

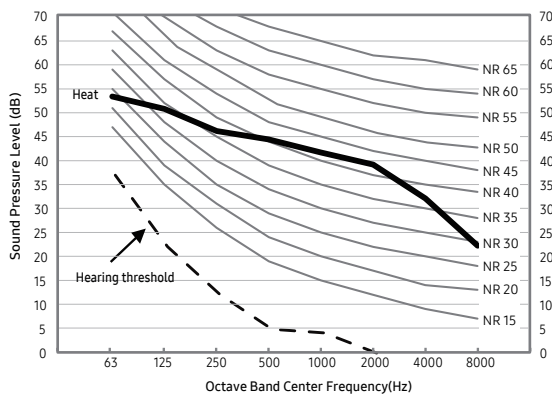

# 2. Outdoor Units

## 2-6. Sound data

### Sound Pressure level

Unit: dB(A)

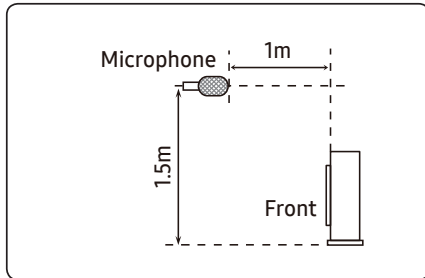

Model	Cooling	Heating
AE080BXDGG/EU	42	42
AE120BXDGG/EU	46	46
AE140BXDGG/EU	47	47

- NR Curve

4) AE080BXDGG/EU

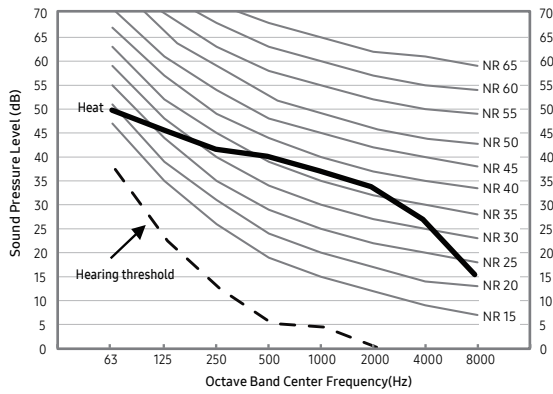

5) AE120BXDGG/EU

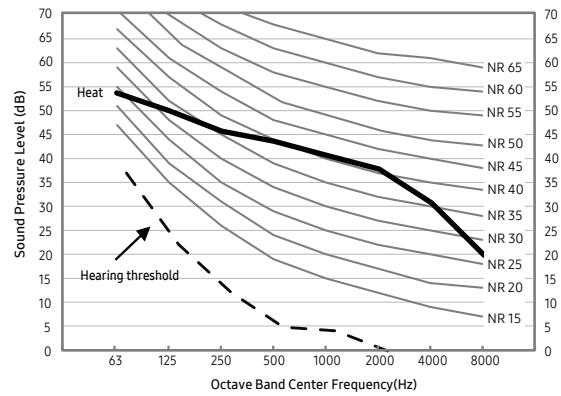

6) AE140BXDGG/EU

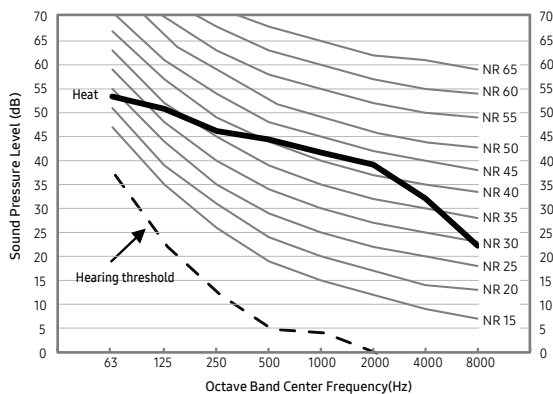

# 2. Outdoor Units

## 2-6. Sound data

### Sound Power level

**NOTE**

- Specifications may be subject to change without prior notice
  - Sound power level is an absolute value that a sound source generates.
  - dBA = A-weighted sound power level.
  - Reference power : 1pW.
  - Measured according to ISO 3741.

Model	Power (dBA)
AE080BXYDEG/EU	56
AE120BXYDEG/EU	59
AE140BXYDEG/EU	60

1) AE080BXYDEG/EU

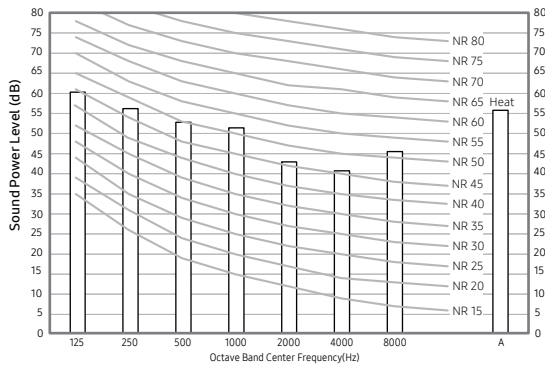

2) AE120BXYDEG/EU

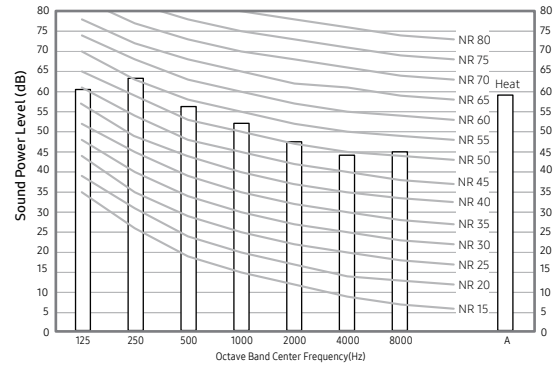

3) AE140BXYDEG/EU

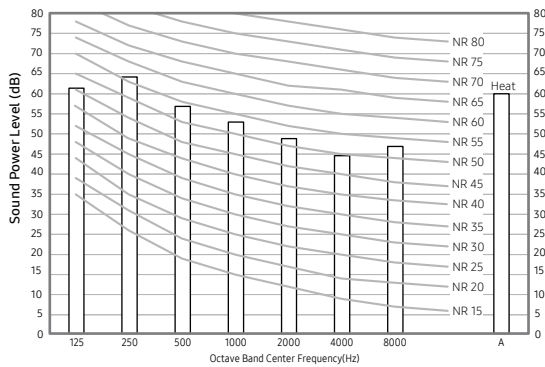



# 2. Outdoor Units

## 2-6. Sound data

### Sound Power level

**NOTE**

- Specifications may be subject to change without prior notice
  - Sound power level is an absolute value that a sound source generates.
  - dBA = A-weighted sound power level.
  - Reference power : 1pW.
  - Measured according to ISO 3741.

Model	Power (dBA)
AE080BXYDGG/EU	56
AE120BXYDGG/EU	59
AE140BXYDGG/EU	60

4) AE080BXYDGG/EU

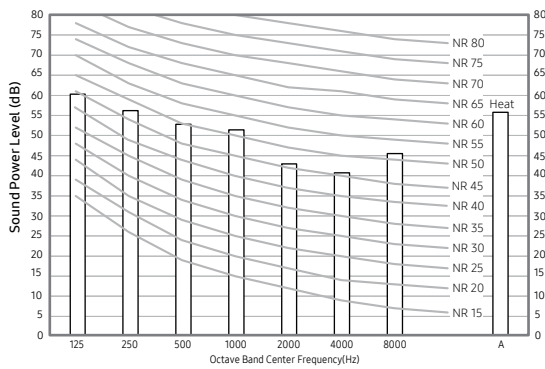

5) AE120BXYDGG/EU

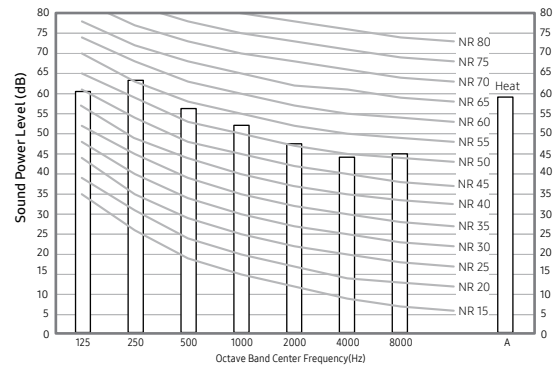

6) AE140BXYDGG/EU

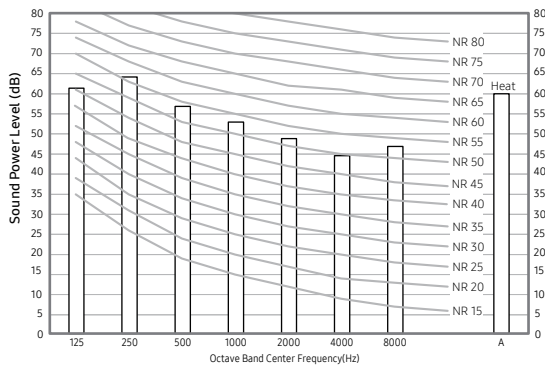

# 2. Outdoor Units

## 2-7. Operation range

### 1) Cooling

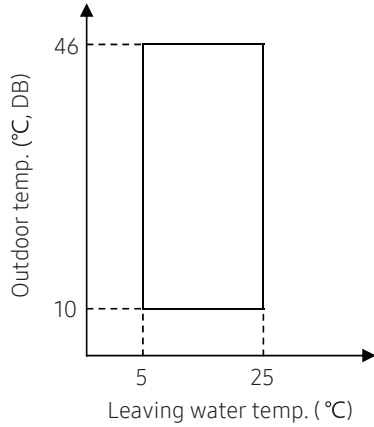

### 2) Heating

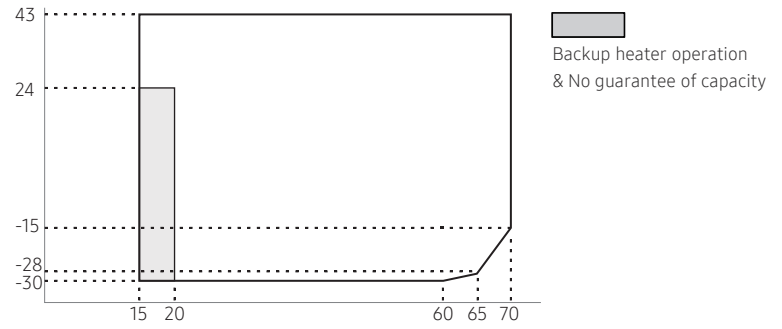

MONO Outdoor Unit		Water Temp. (°C)			Water Flow Rates (LPM)			Air Temp. (°C, DB/WB)		
		Min	Std	Max	Min	Std	Max	Min	Std	Max
Controller	Cooling	5	-	25						
	Heating	15	-	70						
Cooling	Inlet	-	23 (12 <sup>*2</sup> )	30	7	Δ 5°C	58 (48 <sup>*1</sup> )	10/-	35/24	46/28
	Outlet	5	18 (7 <sup>*2</sup> )	25						
Heating	Inlet	5	30 (40 <sup>*2</sup> )	-	-30/-	7/6	43/34.5			
	Outlet	25 (15 <sup>*3</sup> )	35 (45 <sup>*2</sup> )	70						

\*1) Model : AE080BXYDEG/EU  
AE080BXYDGG/EU

\*2) Eurovent Test Condition #2

\*3) Back up heater operation.

### 3) DHW (Domestic Hot Water Tank)

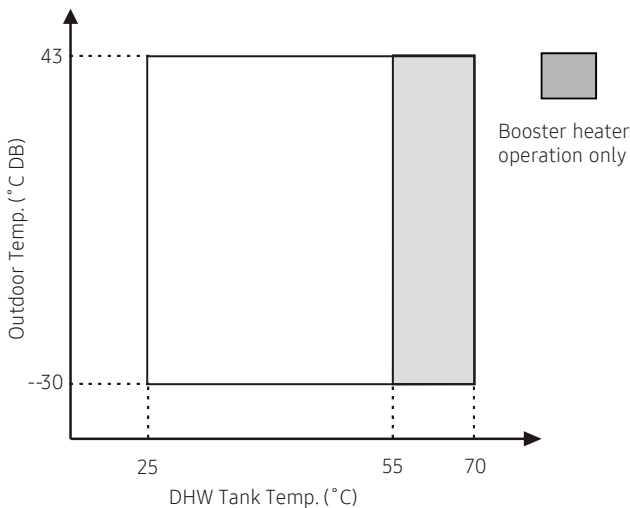

# 2. Outdoor Units

## 2-8 Piping diagram

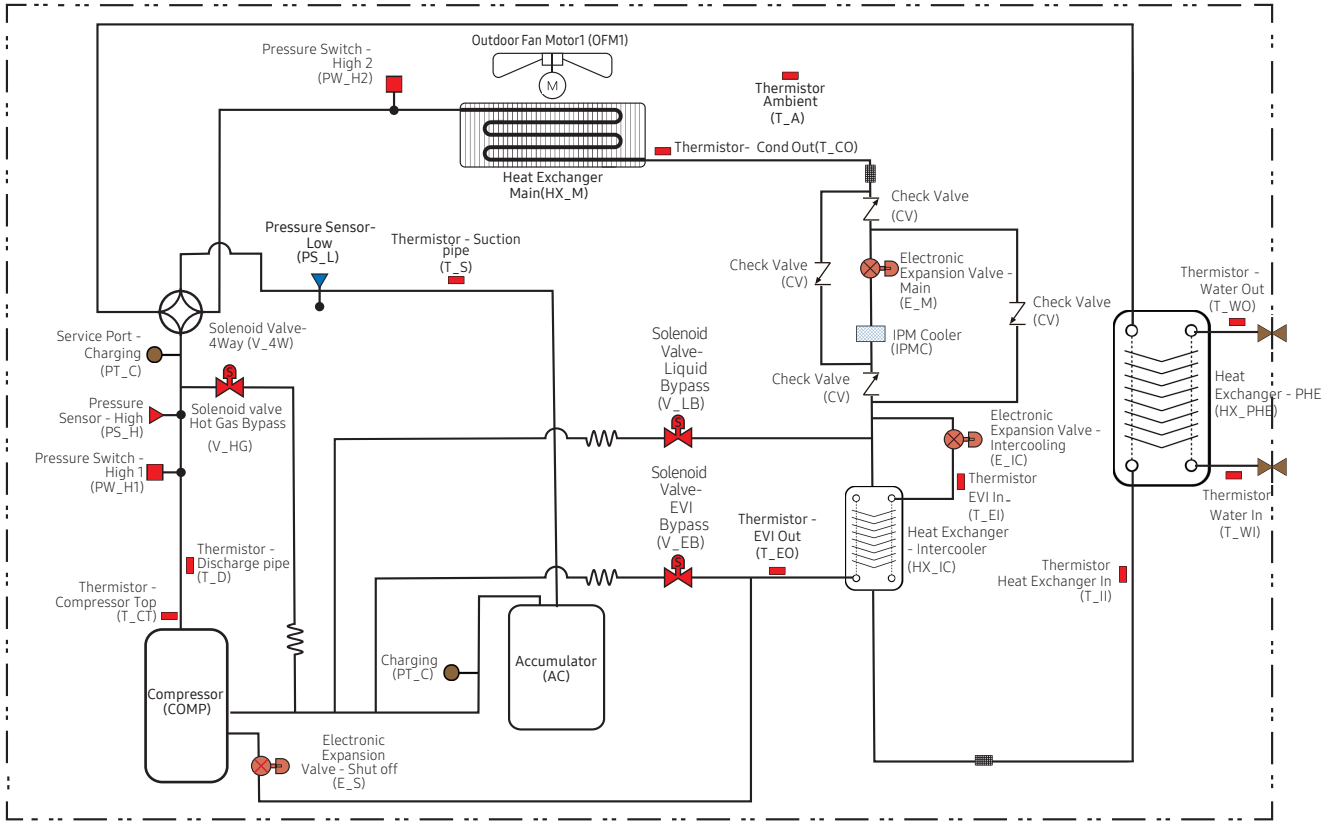









## 2. Outdoor Units

### 2-9. Capacity table

#### 3) Cooling Capacity

LWT (Leaving Water Temp.), Tamb (Ambient Temp.), HC (Heating Capacity), PI (Power input)

	LWT(°C)	7		10		13		15		18		25	
	Tamb(°C)	CC (kW)	PI (kW)	CC (kW)	PI (kW)	CC (kW)	PI (kW)	CC (kW)	PI (kW)	CC (kW)	PI (kW)	CC (kW)	PI (kW)
AE080BXYD*G/EU	10	8.30	1.09	8.52	1.09	8.75	0.99	8.88	0.98	9.33	0.96	10.26	1.01
	20	7.99	1.34	8.20	1.20	8.42	1.19	8.54	1.09	8.97	1.06	9.87	1.04
	30	7.67	1.91	7.87	1.78	8.08	1.65	8.20	1.58	8.61	1.48	9.47	1.41
	35	7.50	2.27	7.62	2.10	7.75	2.01	7.86	1.82	8.00	1.70	9.18	1.59
	46	7.00	3.00	7.12	2.78	7.31	2.61	7.33	2.49	7.79	2.43	8.66	2.07
	AE120BXYD*G/EU	LWT(°C)	7		10		13		15		18		25
	Tamb(°C)	CC (kW)	PI (kW)	CC (kW)	PI (kW)	CC (kW)	PI (kW)	CC (kW)	PI (kW)	CC (kW)	PI (kW)	CC (kW)	PI (kW)
	10	12.73	1.67	13.00	1.66	13.27	1.55	13.40	1.44	13.99	1.42	15.39	1.51
	20	12.25	2.07	12.51	1.83	12.77	1.80	12.89	1.64	13.46	1.56	14.81	1.56
	30	11.75	3.19	12.01	2.93	12.25	2.71	12.37	2.64	12.91	2.48	14.21	2.27
	35	11.50	3.59	11.63	3.42	11.75	3.26	11.86	2.96	12.00	2.64	13.76	2.59
	46	10.73	4.60	10.87	4.34	11.08	4.13	11.06	4.01	11.69	3.90	12.98	3.51
AE140BXYD*G/EU	LWT(°C)	7		10		13		15		18		25	
	Tamb(°C)	CC (kW)	PI (kW)	CC (kW)	PI (kW)	CC (kW)	PI (kW)	CC (kW)	PI (kW)	CC (kW)	PI (kW)	CC (kW)	PI (kW)
	10	13.84	1.94	14.31	1.85	14.91	1.76	15.36	1.71	16.32	1.68	17.96	1.76
	20	13.31	2.24	13.77	2.01	14.34	2.03	14.78	1.88	15.71	1.85	17.28	1.81
	30	12.78	3.86	13.21	3.43	13.77	3.13	14.18	3.03	15.06	2.79	16.58	2.83
	35	12.50	3.97	12.80	3.83	13.20	3.74	13.60	3.44	14.00	3.14	16.06	3.10
	46	11.67	5.10	11.96	4.82	12.45	4.66	12.69	4.60	13.63	4.52	15.15	4.03

1. Heating capacity : Capacity is according to Eurovent rating standard OM-3-2015 and valid for heated water range  $\Delta t = 3\sim 8^{\circ}\text{C}$  (However, if the LWT is over  $60^{\circ}\text{C}$ ,  $\Delta t = 10^{\circ}\text{C}$ .)
  2. Cooling capacity : Capacity is according to Eurovent rating standard OM-3-2015 and valid for chilled water range  $\Delta t = 3\sim 8^{\circ}\text{C}$
  3. Power input : Power input is according to Eurovent rating standard OM-3-2015.
  4. Peak value : Tested without defrost operation in accordance with EN14511
- ※ The real capacity would be changed according to the install environment.



## 2. Outdoor Units

---

### 2-10. Silent mode corrections

---

#### Heating

Silent Function	Outdoor Air Temperature(°C DB)			
	-15	2	7	15
Level 1	0.92	0.90	0.95	0.95
Level 2	0.82	0.80	0.86	0.86
Level 3	0.68	0.67	0.72	0.72
Low-noise	0.54	0.60	0.65	0.65

#### Cooling

Silent Function	Outdoor Air Temperature(°C DB)			
	10	20	35	45
Level 1	1.00	1.00	0.95	0.95
Level 2	0.98	0.98	0.86	0.86
Level 3	0.78	0.78	0.65	0.65
Low-noise	0.70	0.70	0.65	0.65

---

# 3. Tank integrated hydro unit

## 3-1. Specifications

Model Name	Indoor Unit		AE200RNWMEG/EU	AE200RNWMEG/EU	AE200RNWMEG/EU	
	Outdoor Unit		AE080BXYDEG/EU	AE120BXYDEG/EU	AE140BXYDEG/EU	
Mode			-	Heat Pump (A2W)	Heat Pump (A2W)	
Power Supply	Φ, #, V, Hz		1,2,220-240,50	1,2,220-240,50	1,2,220-240,50	
Power input	Cooling (Nominal)	kW	0.2	0.2	0.2	
	Heating (Nominal)	kW	0.2	0.2	0.2	
	Cooling (Max)	kW	0.2	0.2	0.2	
	Heating (Max)	kW	5.2	5.2	5.2	
Current Input	Cooling (Nominal)	A	0.9	0.9	0.9	
	Heating (Nominal)	A	0.9	0.9	0.9	
	Cooling (Max)	A	0.9	0.9	0.9	
	Heating (Max)	A	22.7	22.7	22.7	
Field Wiring	MCA	A	22.7	22.7	22.7	
	MFA		28.4	28.4	28.4	
Heating up time	h/min		1/0	0/54	0/54	
Water Heating	Declared load profile		-	L	L	
	Energy efficiency Class		-	A+	A+	
Connections	Water Flow Rate (Std)	Heating	LPM	23.1	34.6	40.4
		Cooling	LPM	23.1	34.6	40.4
	Water Flow Rate	Min	LPM	7	7	7
		Max	LPM	48	58	58
	Water Pressure (Max)	bar		3	3	3
	Refrigerant pipe (To outdoor unit)	Type	-		-	-
		Liquid	Φ, mm	-		-
		Gas	Φ, mm	-		-
	Water pipe (To outdoor unit)	Type	-		Straight pipe	Straight pipe
		Inlet	Φ, mm	28		28
		Outlet	Φ, mm	28		28
	Water pipe (Space heating)	Type	-		Straight pipe	Straight pipe
		Inlet	Φ, mm	28		28
		Outlet	Φ, mm	28		28
	Water pipe (DHW)	Type	-		Straight pipe	Straight pipe
		Inlet	Φ, mm	22		22
		Outlet	Φ, mm	22		22
	Water pipe (Secondary water return, Only 260L optional)	Type	-		-	-
		Inlet	Φ, mm	-		-
Leaving Water Temperature	Heating Min.	°C	15		15	
	Heating Max.	°C	70		70	
	Cooling Min.	°C	5		5	
	Cooling Max.	°C	25		25	
DHW Tank	Nominal Water Volume	liter	200		200	
	Net Water Volume	liter	194		194	
	Material	-		SUS 316L	SUS 316L	
	Max. water pressure	bar	10		10	
	Max. water temperature	°C	70		70	
	Immersion heater (= booster heater)	kW	3 (230V)		3 (230V)	
	Insulation	-		PU Foam	PU Foam	
Water Pump	Type	-		Centrifurugal (UPMM 25-9.5)	Centrifurugal (UPMM 25-9.5)	
	Motor Input	W	100		100	
	Number of Unit	EA	1		1	
Backup Heater	Power	kW	2 (230V)		2 (230V)	
	Thermostat (Thermal Fuse)	°C	TBD		TBD	
Safety device	Pressure relief valve	bar	2.9		2.9	
	Flow Sensor	LPM	5~60		5~60	
	Temperature & Pressure relief valve (Tank)	bar, °C	7, 90		7, 90	
	Thermostat (for immersion heater)	°C	49~82±5 (Auto, On : 15°C±3°C↓)		49~82±5 (Auto, On : 15°C±3°C↓)	

# 3. Tank integrated hydro unit

## 3-1. Specifications

Model Name	Indoor Unit		AE200RNWMEG/EU	AE200RNWMEG/EU	AE200RNWMEG/EU	
	Outdoor Unit		AE080BXYDEG/EU	AE120BXYDEG/EU	AE140BXYDEG/EU	
Expansion vessel	Internal water volume	liter	8	8	8	
	Working pressure	MPa	0.3	0.3	0.3	
	Max. water pressure	bar	2.9	2.9	2.9	
	Pre Pressure	bar	1	1	1	
Water Pump (Primary)	Type	-	BLDC Inv	BLDC Inv	BLDC Inv	
	Max static pressure	mAq	9.5	9.5	9.5	
Water Heat Exchanger	Type	-	Braszed Plate Exchager	Braszed Plate Exchanger	Braszed Plate Exchanger	
	Quantity	EA	1	1	1	
	Internal water volume	L	1.01(Water Side) 0.98(Refrigerant Side)	1.01(Water Side) 0.98(Refrigerant Side)	1.01(Water Side) 0.98(Refrigerant Side)	
	Water flow rate	Min.	l/min	7	7	7
		Max.	l/min	48	58	58
	Insulation material	-	PE-FOAM	PE-FOAM	PE-FOAM	
IP Class	-		IPX1	IPX1	IPX1	
Air Purge Valve	Φ, inch		BSPP male 3/8	BSPP male 3/8	BSPP male 3/8	
Service Valve	Φ, inch		-	-	-	
Sound	Sound Pressure	Heating	dB(A)	26	30	30
		Cooling	dB(A)	26	30	30
	Sound Power	Heating	dB(A)	40	44	44
Casing	Color	-	Earth brown	Earth brown	Earth brown	
	Material	-	Poweder coated Electrogalvanized steel	Poweder coated Electrogalvanized steel	Poweder coated Electrogalvanized steel	
Packing	Material	-	EPS/BOX	EPS/BOX	EPS/BOX	
	Packing Weight	kg	12.0	12.0	12.0	
External Dimension	Net Weight	kg	130.0	130.0	130.0	
	Shipping Weight	kg	142.0	142.0	142.0	
	Net Dimensions(WxHxD)	mm	595 x 1,800 x 700	595 x 1,800 x 700	595 x 1,800 x 700	
	Shipping Dimensions(WxHxD)	mm	700 x 2,000 x 780	700 x 2,000 x 780	700 x 2,000 x 780	

### NOTE

- Specifications may be subject to change without prior notice.

# 3. Tank integrated hydro unit

## 3-1. Specifications

Model Name	Indoor Unit		AE260RNWMEG/EU	AE260RNWMEG/EU	AE260RNWMEG/EU	
	Outdoor Unit		AE080BXYDEG/EU	AE120BXYDEG/EU	AE140BXYDEG/EU	
Mode			-	Heat Pump (A2W)	Heat Pump (A2W)	
Power Supply	Φ, #, V, Hz		1,2,220-240,50	1,2,220-240,50	1,2,220-240,50	
Power input	Cooling (Nominal)	kW	0.2	0.2	0.2	
	Heating (Nominal)	kW	0.2	0.2	0.2	
	Cooling (Max)	kW	0.2	0.2	0.2	
	Heating (Max)	kW	5.2	5.2	5.2	
Current Input	Cooling (Nominal)	A	0.9	0.9	0.9	
	Heating (Nominal)	A	0.9	0.9	0.9	
	Cooling (Max)	A	0.9	0.9	0.9	
	Heating (Max)	A	22.7	22.7	22.7	
Field Wiring	MCA	A	22.7	22.7	22.7	
	MFA		28.4	28.4	28.4	
Heating up time	h /min		1/24	1/12	1/12	
Water Heating	Declared load profile		-	XL	XL	
	Energy efficiency Class		-	A	A	
Connections	Water Flow Rate (Std)	Heating	LPM	23.1	34.6	40.4
		Cooling	LPM	23.1	34.6	40.4
	Water Flow Rate	Min	LPM	7	7	7
		Max	LPM	48	58	58
	Water Pressure (Max)	bar		3	3	3
	Refrigerant pipe (To outdoor unit)	Type	-		-	-
		Liquid	Φ, mm	-		-
		Gas	Φ, mm	-		-
	Water pipe (To outdoor unit)	Type	-		Straight pipe	Straight pipe
		Inlet	Φ, mm	28		28
		Outlet	Φ, mm	28		28
	Water pipe (Space heating)	Type	-		Straight pipe	Straight pipe
		Inlet	Φ, mm	28		28
		Outlet	Φ, mm	28		28
	Water pipe (DHW)	Type	-		Straight pipe	Straight pipe
		Inlet	Φ, mm	22		22
		Outlet	Φ, mm	22		22
	Water pipe (Secondary water return, Only 260L optional)	Type	-		Straight pipe	Straight pipe
		Inlet	Φ, mm	22		22
	Leaving Water Temperature	Heating Min.	°C	15		15
Heating Max.		°C	70		70	
Cooling Min.		°C	5		5	
Cooling Max.		°C	25		25	
DHW Tank	Nominal Water Volume	liter	260		260	
	Net Water Volume	liter	254		254	
	Material	-		SUS 316L	SUS 316L	
	Max. water pressure	bar	10		10	
	Max. water temperature	°C	70		70	
	Immersion heater (= booster heater)	kW	3 (230V)		3 (230V)	
	Insulation	-		PU Foam	PU Foam	
Water Pump	Type	-		Centrifurugal (UPMM 25-9.5)	Centrifurugal (UPMM 25-9.5)	
	Motor Input	W	100		100	
	Number of Unit	EA	1		1	
Backup Heater	Power	kW	2 (230V)		2 (230V)	
	Thermostat (Thermal Fuse)	°C	TBD		TBD	
Safety device	Pressure relief valve	bar	2.9		2.9	
	Flow Sensor	LPM	5~60		5~60	
	Temperature & Pressure relief valve (Tank)	bar, °C	7, 90		7, 90	
	Thermostat (for immersion heater)	°C	49~82±5 (Auto, On : 15°C±3°C↓)		49~82±5 (Auto, On : 15°C±3°C↓)	

# 3. Tank integrated hydro unit

## 3-1. Specifications

Model Name	Indoor Unit		AE260RNWMEG/EU	AE260RNWMEG/EU	AE260RNWMEG/EU	
	Outdoor Unit		AE080BXYDEG/EU	AE120BXYDEG/EU	AE140BXYDEG/EU	
Expansion vessel	Internal water volume	liter	8	8	8	
	Working pressure	MPa	0.3	0.3	0.3	
	Max. water pressure	bar	2.9	2.9	2.9	
	Pre Pressure	bar	1	1	1	
Water Pump (Primary)	Type	-	BLDC Inv	BLDC Inv	BLDC Inv	
	Max static pressure	mAq	9.5	9.5	9.5	
Water Heat Exchanger	Type	-	Braszed Plate Exchager	Braszed Plate Exchanger	Braszed Plate Exchanger	
	Quantity	EA	1	1	1	
	Internal water volume	L	1.01(Water Side) 0.98(Refrigerant Side)	1.01(Water Side) 0.98(Refrigerant Side)	1.01(Water Side) 0.98(Refrigerant Side)	
	Water flow rate	Min.	l/min	7	7	7
		Max.	l/min	48	58	58
	Insulation material	-	PE-FOAM	PE-FOAM	PE-FOAM	
IP Class			-	IPX1	IPX1	
Air Purge Valve			Φ, inch	BSPP male 3/8	BSPP male 3/8	
Service Valve			Φ, inch	-	-	
Sound	Sound Pressure	Heating	dB(A)	26	30	30
		Cooling	dB(A)	26	30	30
	Sound Power	Heating	dB(A)	40	44	44
Casing	Color	-	Earth brown	Earth brown	Earth brown	
	Material	-	Poweder coated ElectroGalvanized steel	Poweder coated ElectroGalvanized steel	Poweder coated ElectroGalvanized steel	
Packing	Material	-	EPS/BOX	EPS/BOX	EPS/BOX	
	Packing Weight	kg	12.0	12.0	12.0	
External Dimension	Net Weight	kg	140.0	140.0	140.0	
	Shipping Weight	kg	152.0	152.0	152.0	
	Net Dimensions(WxHxD)	mm	595 x 1,800 x 700	595 x 1,800 x 700	595 x 1,800 x 700	
	Shipping Dimensions(WxHxD)	mm	700 x 2,000 x 780	700 x 2,000 x 780	700 x 2,000 x 780	

### NOTE

- Specifications may be subject to change without prior notice.

# 3. Tank integrated hydro unit

## 3-1. Specifications

Model Name		Indoor Unit	AE260RNWMGG/EU	AE260RNWMGG/EU	AE260RNWMGG/EU	
		Outdoor Unit	AE080BXYDGG/EU	AE120BXYDGG/EU	AE140BXYDGG/EU	
Mode		-	Heat Pump (A2W)	Heat Pump (A2W)	Heat Pump (A2W)	
Power Supply		Φ, #, V, Hz	1,2,220-240,50 3,4,380-415,50	1,2,220-240,50 3,4,380-415,50	1,2,220-240,50 3,4,380-415,50	
Power input	Cooling (Nominal)	kW	3Φ - / 1Φ 0.20	3Φ - / 1Φ 0.20	3Φ - / 1Φ 0.20	
	Heating (Nominal)	kW	3Φ - / 1Φ 0.20	3Φ - / 1Φ 0.20	3Φ - / 1Φ 0.20	
	Cooling (Max)	kW	3Φ - / 1Φ 0.20	3Φ - / 1Φ 0.20	3Φ - / 1Φ 0.20	
	Heating (Max)	kW	3Φ 6.00 / 1Φ 3.20	3Φ 6.00 / 1Φ 3.20	3Φ 6.00 / 1Φ 3.20	
Current Input	Cooling (Nominal)	A	3Φ - / 1Φ 0.9	3Φ - / 1Φ 0.9	3Φ - / 1Φ 0.9	
	Heating (Nominal)	A	3Φ - / 1Φ 0.9	3Φ - / 1Φ 0.9	3Φ - / 1Φ 0.9	
	Cooling (Max)	A	3Φ - / 1Φ 0.9	3Φ - / 1Φ 0.9	3Φ - / 1Φ 0.9	
	Heating (Max)	A	3Φ 8.7 / 1Φ 14.0	3Φ 8.7 / 1Φ 14.0	3Φ 8.7 / 1Φ 14.0	
Field Wiring	MCA	A	3Φ 8.7 / 1Φ 14.0	3Φ 8.7 / 1Φ 14.0	3Φ 8.7 / 1Φ 14.0	
	MFA		3Φ 10.9 / 1Φ 17.5	3Φ 10.9 / 1Φ 17.5	3Φ 10.9 / 1Φ 17.5	
Heating up time		h/min	1 / 24	1 / 12	1 / 12	
Water Heating	Declared load profile		-	XL	XL	
	Energy efficiency Class		-	A	A	
Connections	Water Flow Rate (Std)	Heating	LPM	23.1	34.6	40.4
		Cooling	LPM	23.1	34.6	40.4
	Water Flow Rate	Min	LPM	7	7	7
		Max	LPM	48	58	58
	Water Pressure (Max)		bar	3	3	3
	Refrigerant pipe (To outdoor unit)	Type	-	-	-	-
		Liquid	Φ, mm	-	-	-
		Gas	Φ, mm	-	-	-
	Water pipe (To outdoor unit)	Type	-	Straight pipe	Straight pipe	Straight pipe
		Inlet	Φ, mm	28	28	28
		Outlet	Φ, mm	28	28	28
	Water pipe (Space heating)	Type	-	Straight pipe	Straight pipe	Straight pipe
		Inlet	Φ, mm	28	28	28
		Outlet	Φ, mm	28	28	28
	Water pipe (DHW)	Type	-	Straight pipe	Straight pipe	Straight pipe
		Inlet	Φ, mm	22	22	22
		Outlet	Φ, mm	22	22	22
	Water pipe (Secondary water return, Only 260L optional)	Type	-	Straight pipe	Straight pipe	Straight pipe
		Inlet	Φ, mm	22	22	22
	Leaving Water Temperature	Heating Min.	°C	15	15	15
Heating Max.		°C	70	70	70	
Cooling Min.		°C	5	5	5	
Cooling Max.		°C	25	25	25	
DHW Tank	Nominal Water Volume		liter	260	260	260
	Net Water Volume		liter	254	254	254
	Material		-	SUS 316L	SUS 316L	SUS 316L
	Max. water pressure		bar	10	10	10
	Max. water temperature		°C	70	70	70
	Immersion heater (= booster heater)		kW	3 (230V)	3 (230V)	3 (230V)
	Insulation		-	PU Foam	PU Foam	PU Foam
Water Pump	Type		-	Centrifurugal (UPMM 25-9.5)	Centrifurugal (UPMM 25-9.5)	Centrifurugal (UPMM 25-9.5)
	Motor Input		W	100	100	100
	Number of Unit		EA	1	1	1
Backup Heater	Power		kW	6 (3Φ 400V)	6 (3Φ 400V)	6 (3Φ 400V)
	Thermostat (Thermal Fuse)		°C	TBD	TBD	TBD
Safety device	Pressure relief valve		bar	2.9	2.9	2.9
	Flow Sensor		LPM	5~60	5~60	5~60
	Temperature & Pressure relief valve (Tank)		bar, °C	7, 90	7, 90	7, 90
	Thermostat (for immersion heater)		°C	49~82±5 (Auto, On : 15°C±3°C↓)	49~82±5 (Auto, On : 15°C±3°C↓)	49~82±5 (Auto, On : 15°C±3°C↓)

# 3. Tank integrated hydro unit

## 3-1. Specifications

Model Name	Indoor Unit		AE260RNWMGG/EU	AE260RNWMGG/EU	AE260RNWMGG/EU	
	Outdoor Unit		AE080BXYDGG/EU	AE120BXYDGG/EU	AE140BXYDGG/EU	
Expansion vessel	Internal water volume	liter	8	8	8	
	Working pressure	MPa	0.3	0.3	0.3	
	Max. water pressure	bar	2.9	2.9	2.9	
	Pre Pressure	bar	1	1	1	
Water Pump (Primary)	Type	-	BLDC Inv	BLDC Inv	BLDC Inv	
	Max static pressure	mAq	9.5	9.5	9.5	
Water Heat Exchanger	Type	-	Braszed Plate Exchager	Braszed Plate Exchanger	Braszed Plate Exchanger	
	Quantity	EA	1	1	1	
	Internal water volume	L	1.01(Water Side) 0.98(Refrigerant Side)	1.01(Water Side) 0.98(Refrigerant Side)	1.01(Water Side) 0.98(Refrigerant Side)	
	Waterflow rate	Min.	L/min	7	7	7
		Max.	L/min	48	58	58
	Insulation material	-	PE-FOAM	PE-FOAM	PE-FOAM	
IP Class	-	-	IPX1	IPX1	IPX1	
Air Purge Valve	Φ, inch		BSPP male 3/8	BSPP male 3/8	BSPP male 3/8	
Service Valve	Φ, inch		-	-	-	
Sound	Sound Pressure	Heating	dB(A)	26	30	30
		Cooling	dB(A)	26	30	30
	Sound Power	Heating	dB(A)	40	44	44
Casing	Color	-	Earth brown	Earth brown	Earth brown	
	Material	-	Poweder coatedElectro galvanized steel	Poweder coatedElectro galvanized steel	Poweder coatedElectro galvanized steel	
Packing	Material	-	EPS/BOX	EPS/BOX	EPS/BOX	
	Packing Weight	kg	12.0	12.0	12.0	
External Dimension	Net Weight	kg	140.0	140.0	140.0	
	Shipping Weight	kg	152.0	152.0	152.0	
	Net Dimensions(WxHxD)	mm	595 x 1,800 x 700	595 x 1,800 x 700	595 x 1,800 x 700	
	Shipping Dimensions(WxHxD)	mm	700 x 2,000 x 780	700 x 2,000 x 780	700 x 2,000 x 780	

### NOTE

- Specifications may be subject to change without prior notice.

# 3. Tank integrated hydro unit

## 3-2. Dimensional drawing

AE200/260RNW\*\*G/EU

Unit : mm

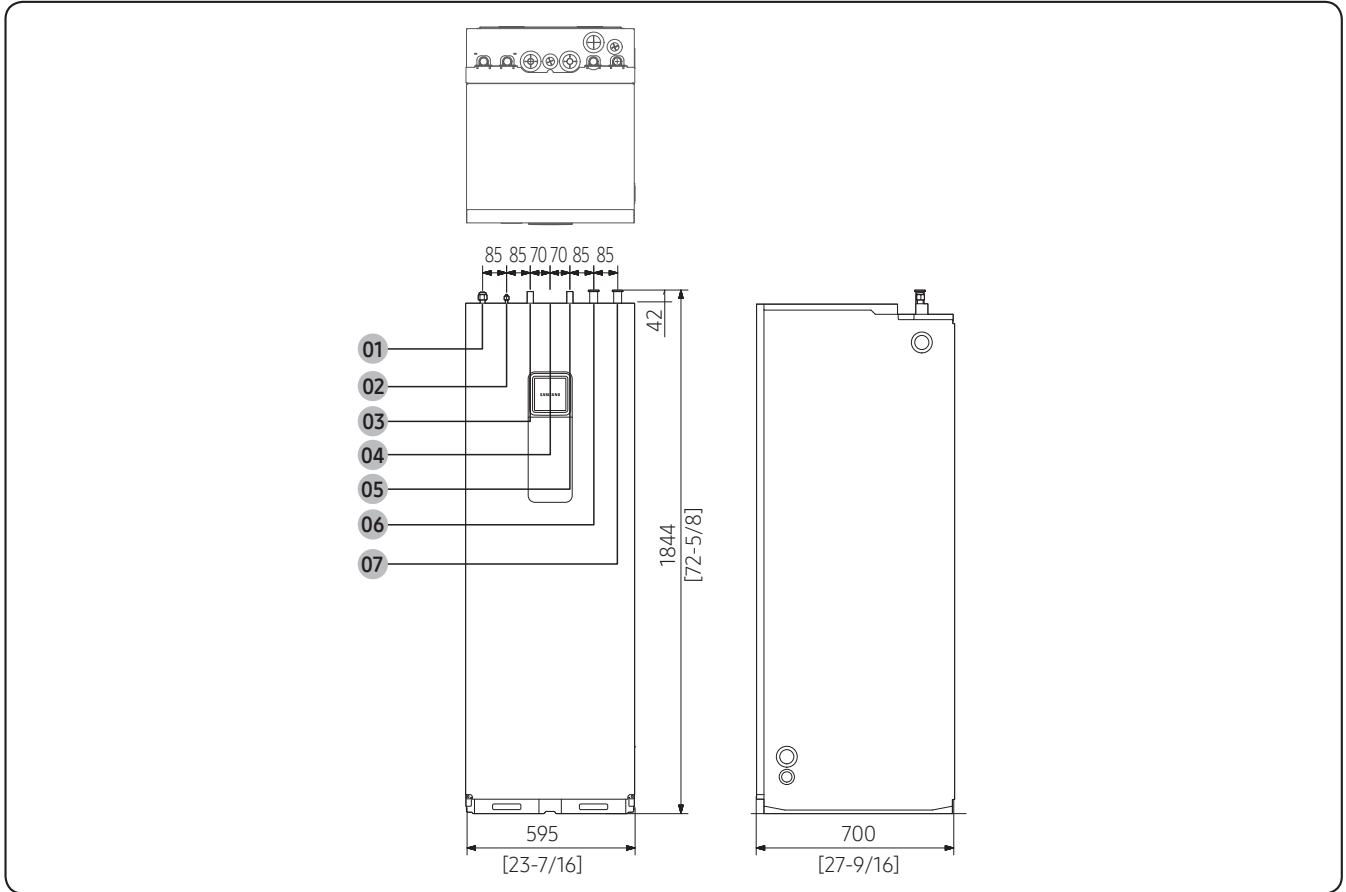

NO	Name	Description
01	Mono outdoor outlet	Ø28, T1.2
02	Mono outdoor inlet	Ø28, T1.2
03	Hot water outlet	Ø22, T1.0
04	Secondary return (260L option)	Ø22, T1.0
05	Cold water inlet	Ø22, T1.0
06	Space heating outlet	Ø28, T1.2
07	Space heating inlet	Ø28, T1.2



# 3. Tank integrated hydro unit

## 3-2. Dimensional drawing

### Main components

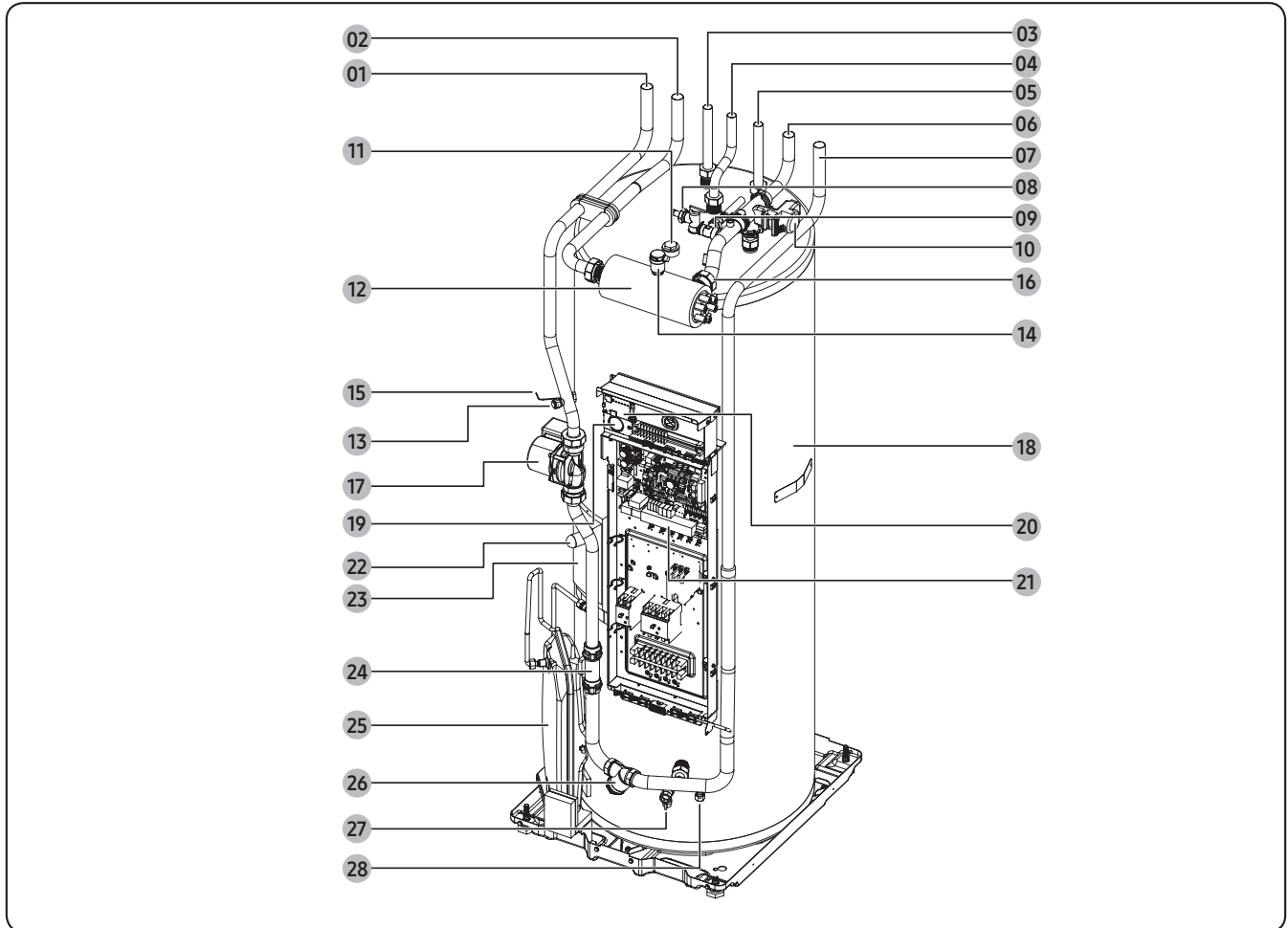

NO	Part name	Note	NO	Part name	Note
01	Water pipe (Return to heat pump)	ø28, Straight pipe	15	Tank thermistor	
02	Water pipe (Flow from heat pump)	ø28, Straight pipe	16	Heater thermistor	
03	Hot water outlet	ø22, Straight pipe	17	Water pump	
04	Secondary return	ø22, Straight pipe (260 L option)	18	Water tank	200 L / 260 L
05	Cold water inlet	ø22, Straight pipe	19	Manometer	0~4 bar
06	Space heating outlet	ø28, Straight pipe	20	S/D converter	
07	Space heating inlet	ø28, Straight pipe	21	Control box	
08	T/P valve	7 bar, 90°C	22	Booster heater	3kW
09	Pressure relief valve	3 bar, BSPP 1/2"	23	Booster heater thermostat	
10	3-way valve		24	Flow sensor	
11	Anode bar	BSPP 1"	25	Expansion vessel	8 L, Pre-charge gas: 0.1 MPa, N2, BSPP 3/8"
12	Back-up heater		26	Strainer	
13	Drain port		27	Tank drain valve	
14	Air vent	BSPP 3/8"	28	Drain port	Primary circuit

# 3. Tank integrated hydro unit

## 3-3. Electrical wiring diagram

### AE200/260RNWMEG/EU

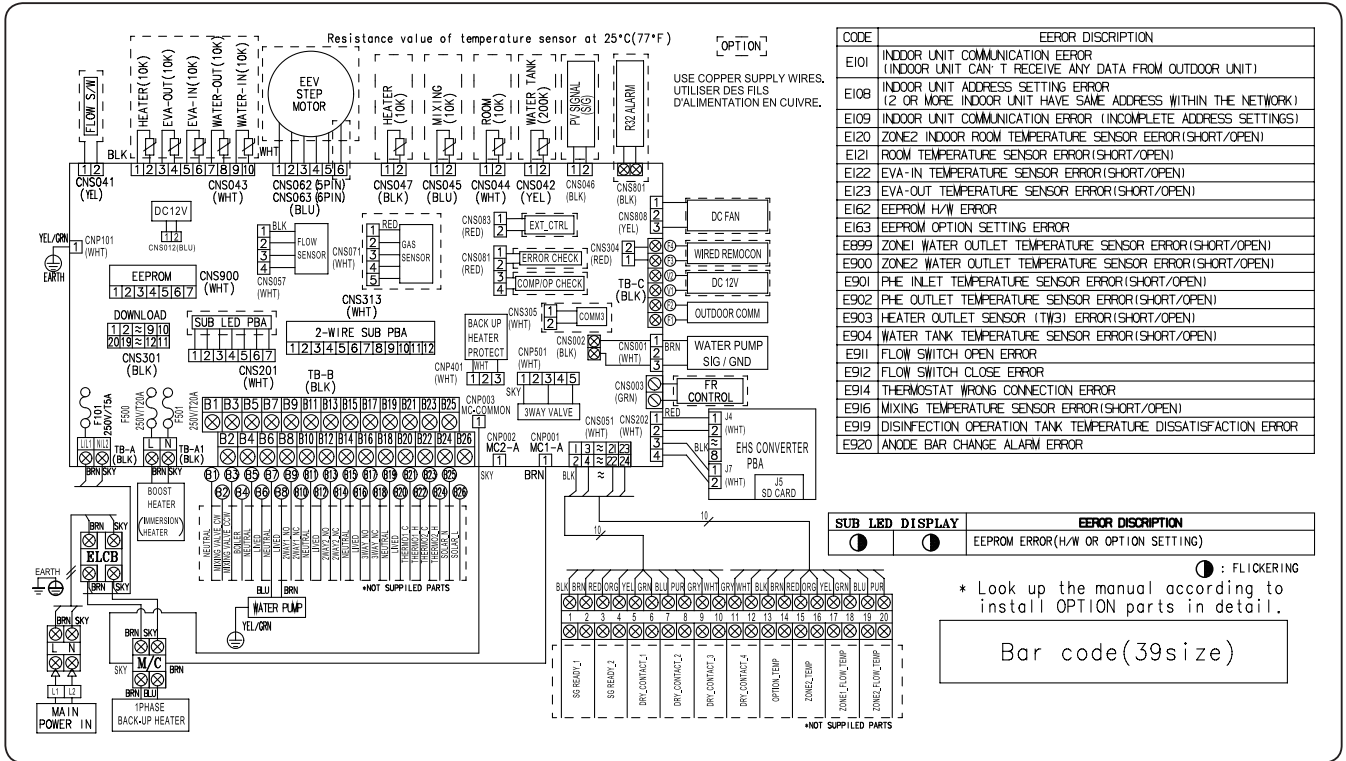

\* It does not support external input(CNS083)/output(CNS081) signal function

HEATER	Thermistor HEATER(10K)	EVA-OUT	Thermistor EVA-OUT(10K)
EVA-IN	Thermistor EVA-IN(10K)	WATER-OUT	Thermistor WATER-OUT(10K)
WATER-IN	Thermistor WATER-IN(10K)	WATER TANK	Thermistor WATER TANK(200K)
MIXING	Thermistor MIXING VALVE(10K)	WIRED REMOCON	Wired Remote Controller
OUTDOOR COMM	Outdoor Communication	SIG/GND	Signal/Ground
ELCB	Earth Leakage Circuit Breaker	M/C	Magnetic Contactor

### NOTES

1. This wiring diagram applies only to the Indoor unit.
2. Symbols show as follow :  
BLK: black, RED: red, BLU: blue, WHT: white, yel: yellow, BRN: brown, SKY: skyblue, GRN: green
3. For connection wiring indoor-outdoor transmission F1-F2.
4. Protective earth(SCREW)

# 3. Tank integrated hydro unit

## 3-3. Electrical wiring diagram

### AE200/260RNWMGG/EU

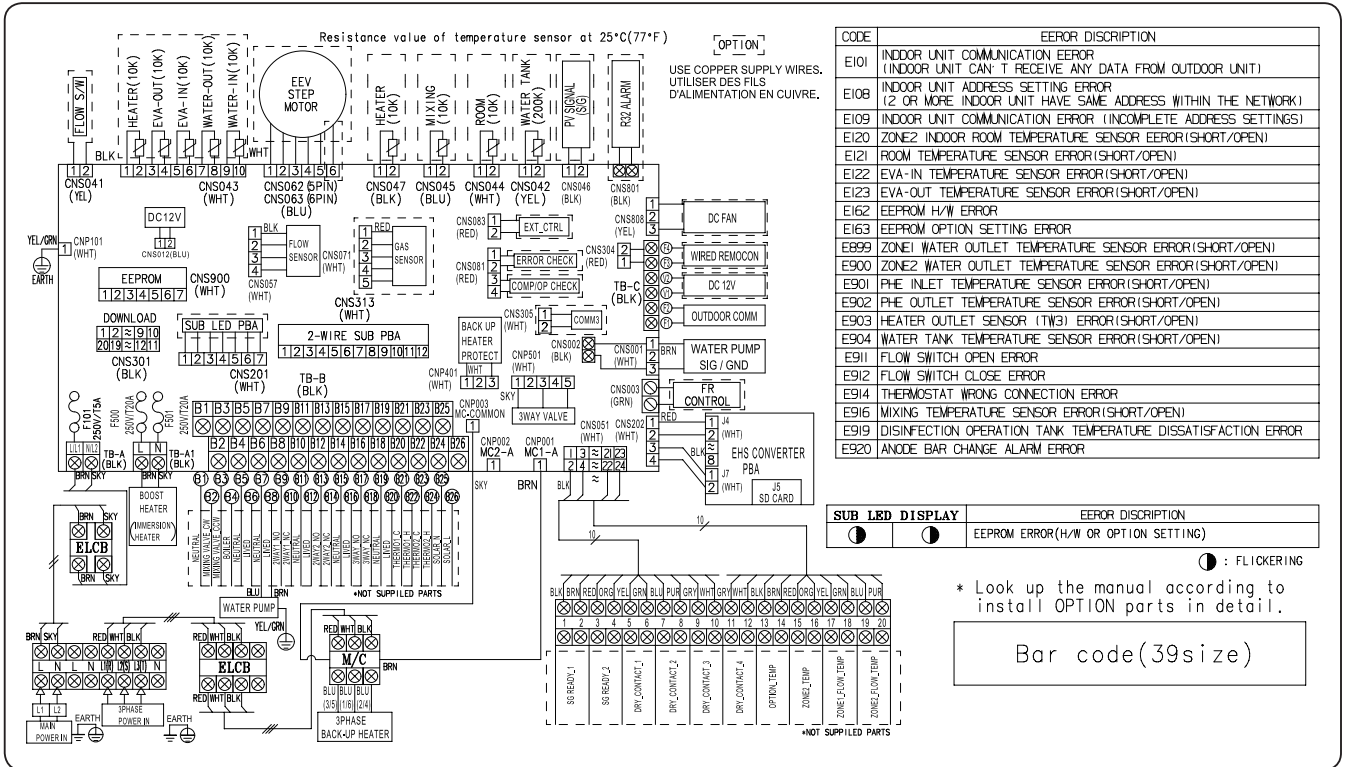

※ It does not support external input(CNS083)/output(CNS081) signal function

HEATER	Thermistor HEATER(10K)	EVA-OUT	Thermistor EVA-OUT(10K)
EVA-IN	Thermistor EVA-IN(10K)	WATER-OUT	Thermistor WATER-OUT(10K)
WATER-IN	Thermistor WATER-IN(10K)	WATER TANK	Thermistor WATER TANK(200K)
MIXING	Thermistor MIXING VALVE(10K)	WIRED REMOCON	Wired Remote Controller
OUTDOOR COMM	Outdoor Communication	SIG/GND	Signal/Ground
ELCB	Earth Leakage Circuit Breaker	M/C	Magnetic Contactor

### NOTES

1. This wiring diagram applies only to the Indoor unit.
2. Symbols show as follow :  
BLK: black, RED: red, BLU: blue, WHT: white, yel: yellow, BRN: brown, SKY: skyblue, GRN: green
3. For connection wiring indoor-outdoor transmission F1-F2.
4. Protective earth(SCREW)

# 3. Tank integrated hydro unit

## 3-4. Sound data

Capacity (Liter)	Model	Sound Pressure dB(A) (Heating)	Sound Power dB(A) (Heating)
200	AE200RNWMEG/EU+AE080BXYDEG/EU	26	40
	AE200RNWMEG/EU+AE120BXYDEG/EU	30	44
	AE200RNWMEG/EU+AE140BXYDEG/EU	30	44
260	AE260RNWM*G/EU+AE080BXYD*G/EU	26	40
	AE260RNWM*G/EU+AE120BXYD*G/EU	30	44
	AE260RNWM*G/EU+AE140BXYD*G/EU	30	44

### NOTE

- Specifications may be subject to change without prior notice.
- Sound Pressure Level
  - Sound pressure level is obtained in an anechoic room.
  - Sound pressure level is a relative value, depending on the distance and acoustic environment.
  - Sound pressure level may differ depending on operation condition.
  - dBA = A-weighted sound pressure level
  - Reference acoustic pressure 0 dB = 20μPa
- Sound Power Level
  - Sound power level is an absolute value that a sound source generates.
  - dBA = A-weighted sound power level.
  - Reference power : 1pW.
  - Measured according to ISO 3741.

# 3. Tank integrated hydro unit

## 3-4. Sound data

### Sound Pressure level

Unit: dB(A)

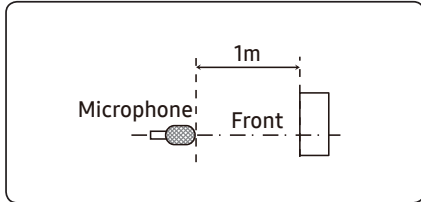

Model	Heating
AE200RNWMEG/EU+AE080BXYDEG/EU	26
AE200RNWMEG/EU+AE120BXYDEG/EU	30
AE200RNWMEG/EU+AE140BXYDEG/EU	30

- NR Curve

1) AE200RNWMEG/EU+AE080BXYDEG/EU

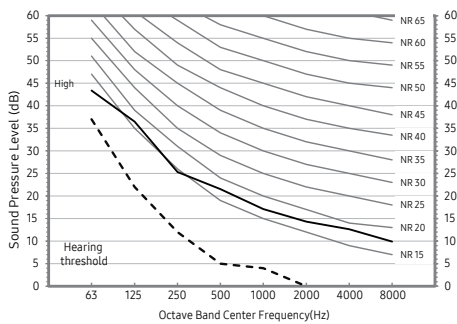

2) AE200RNWMEG/EU+AE120BXYDEG/EU

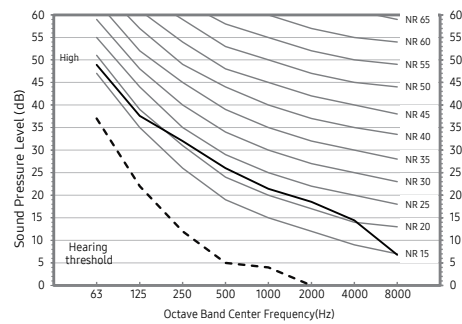

3) AE200RNWMEG/EU+AE140BXYDEG/EU

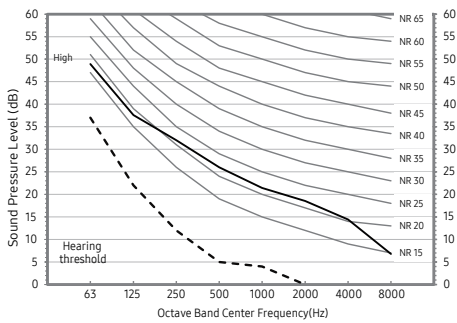

### NOTE

- Specifications may be subject to change without prior notice.
- Sound Pressure Level
  - Sound pressure level is obtained in an anechoic room.
  - Sound pressure level is a relative value, depending on the distance and acoustic environment.
  - Sound pressure level may differ depending on operation condition.
  - dBA = A weighted sound pressure level
  - Reference acoustic pressure 0 dB = 20μPa

# 3. Tank integrated hydro unit

## 3-4. Sound data

### Sound Pressure level

Unit: dB(A)

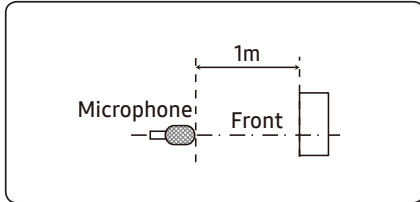

Model	Heating
AE260RNWM*G/EU+AE080BXYD*G/EU	26
AE260RNWM*G/EU+AE120BXYD*G/EU	30
AE260RNWM*G/EU+AE140BXYD*G/EU	30

- NR Curve

1) AE260RNWM\*G/EU+AE080BXYD\*G/EU

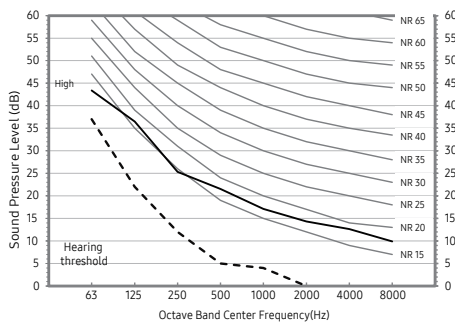

2) AE260RNWM\*G/EU+AE120BXYD\*G/EU

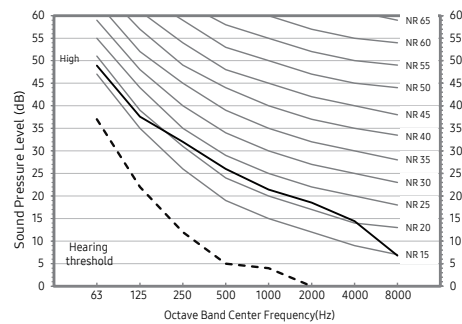

3) AE260RNWM\*G/EU+AE140BXYD\*G/EU

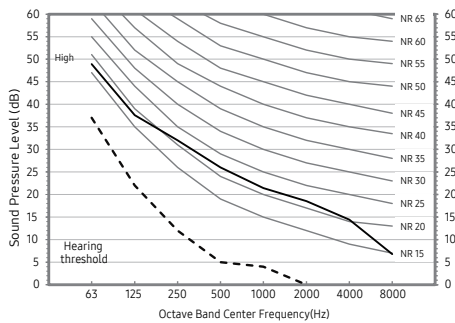

### NOTE

- Specifications may be subject to change without prior notice.
- Sound Pressure Level
  - Sound pressure level is obtained in an anechoic room.
  - Sound pressure level is a relative value, depending on the distance and acoustic environment.
  - Sound pressure level may differ depending on operation condition.
  - dBA = A weighted sound pressure level
  - Reference acoustic pressure 0 dB = 20μPa

# 3. Tank integrated hydro unit

## 3-4. Sound data

### Sound Power level

**NOTE**

- Specifications may be subject to change without prior notice
  - Sound power level is an absolute value that a sound source generates.
  - dBA = A-weighted sound power level.
  - Reference power : 1pW.
  - Measured according to ISO 3741.

Model	Power (dBA)
AE200RNWMEG/EU + AE080BXYDEG/EU	40
AE200RNWMEG/EU + AE120BXYDEG/EU	44
AE200RNWMEG/EU + AE140BXYDEG/EU	44

1) AE200RNWMEG/EU+AE080BXYDEG/EU

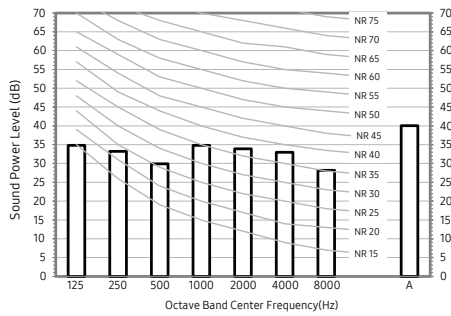

2) AE200RNWMEG/EU+AE120BXYDEG/EU

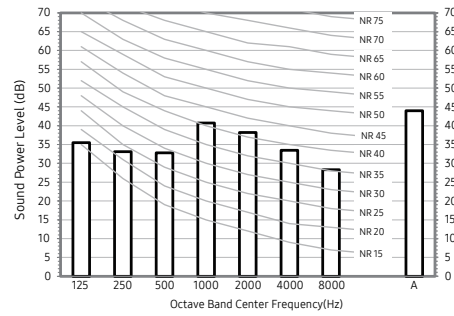

3) AE200RNWMEG/EU+AE140BXYDEG/EU

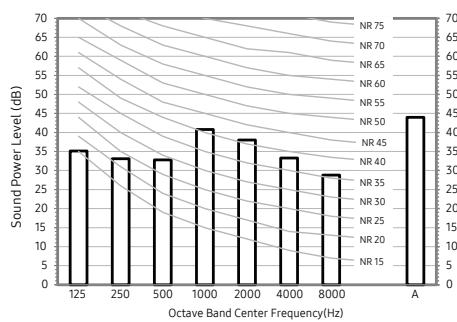

# 3. Tank integrated hydro unit

## 3-4. Sound data

### Sound Power level

**NOTE**

- Specifications may be subject to change without prior notice
  - Sound power level is an absolute value that a sound source generates.
  - dBA = A-weighted sound power level.
  - Reference power : 1pW.
  - Measured according to ISO 3741.

Model	Power (dBA)
AE260RNWM*G/EU + AE080BXYD*G/EU	40
AE260RNWM*G/EU + AE120BXYD*G/EU	44
AE260RNWM*G/EU + AE140BXYD*G/EU	44

1) AE260RNWM\*G/EU+AE080BXYD\*G/EU

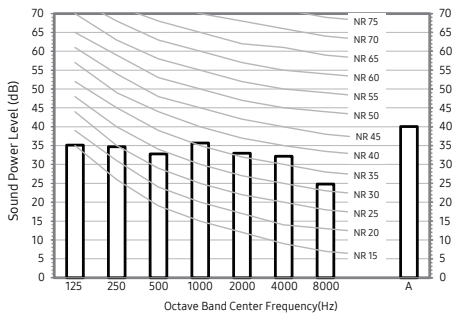

2) AE260RNWM\*G/EU+AE120BXYD\*G/EU

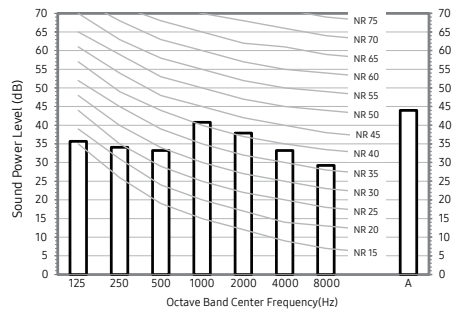

3) AE260RNWM\*G/EU+AE140BXYD\*G/EU

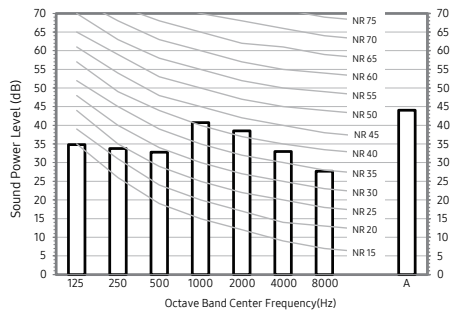



# 3. Tank integrated hydro unit

## 3-5. Piping diagram

AE200/260RNWM\*G/EU

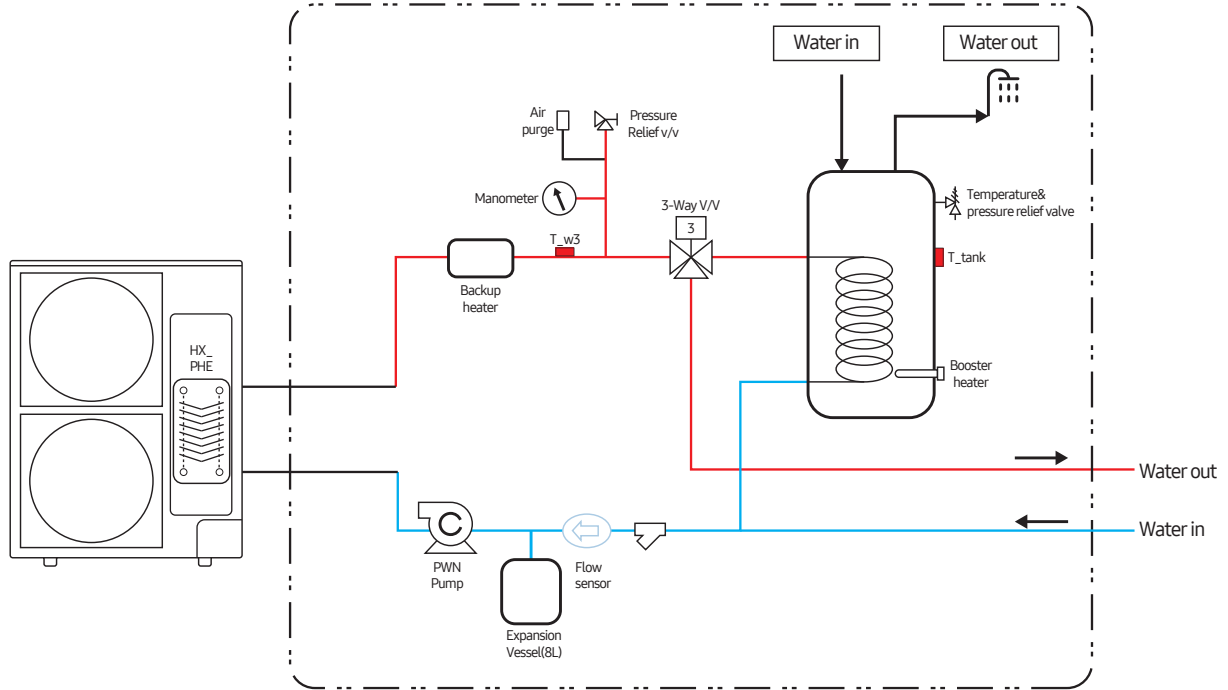

# 4. Installation

## Tank integrated hydro unit

### Mono outdoor + Tank Integrated Hydro Unit

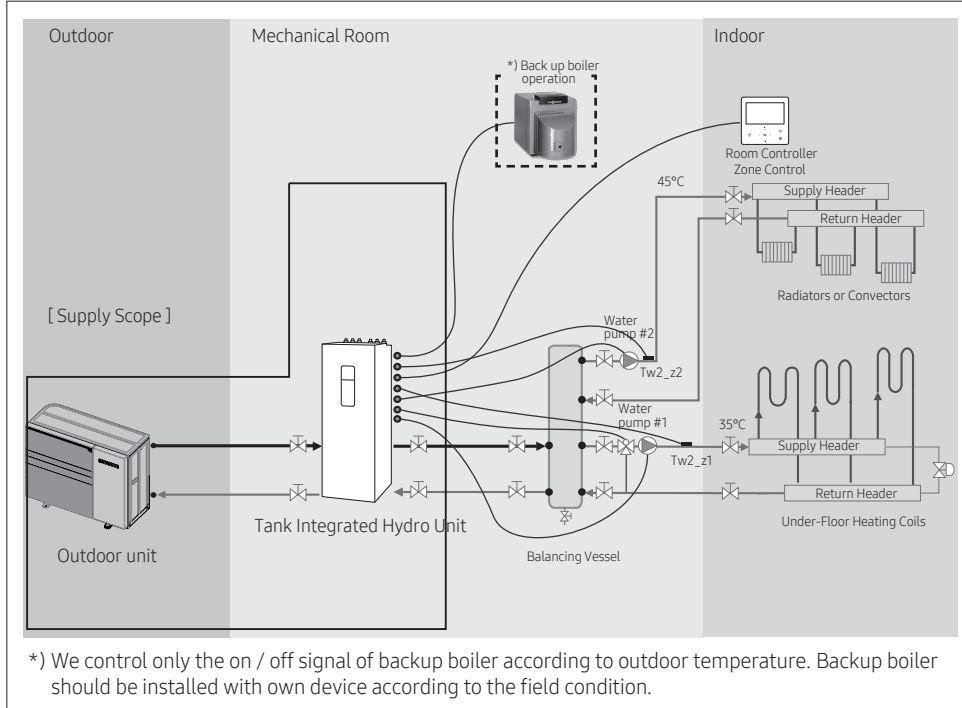

• Samsung is not responsible for performance and stability of the backup boiler.

### Mono outdoor + Control kit

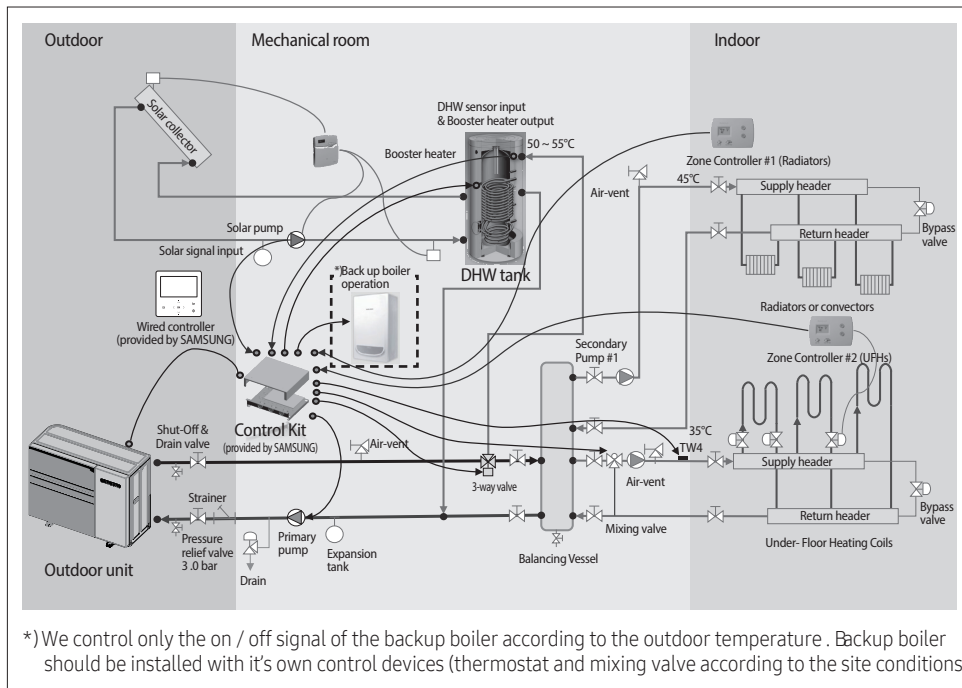

• Samsung is not responsible for performance and stability of the backup boiler.

# 4. Installation

## Tank integrated hydro unit

### Installation of mixing valve

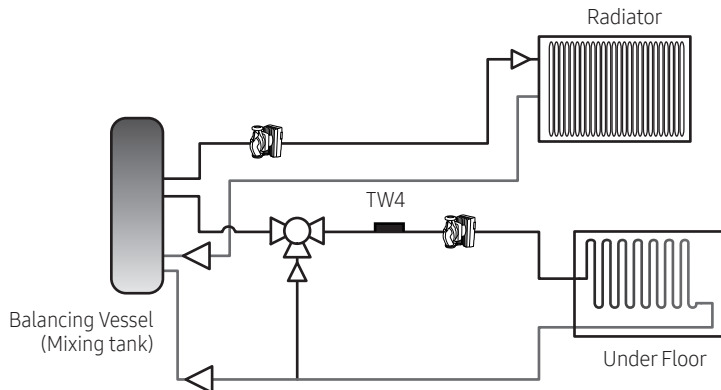

When two different zones are used with different temperature, adjust the temperature of discharge water to high temperature water and control the amount of bypass to provide low temperature water by applying the mixing valve and temperature sensor of the mixing valve (TW4).

1. Select a mixing valve from the manufacturers as below (recommended) and install it at the entrance of the zone.
2. Install the supplied temperature sensor (TW4) on the rear part of the mixing valve. Install TW4 Sensor within 1m of Mixing Valve.
3. Since running time varies depending on the manufacturer, set the FSV (default 90 sec.) by referring to the FSV value below.

Maker		BELIMO	SIEMENS	HONEYWELL
Model code	3 Way Valve	R3020-6P3-S2	VXP45.20-4 (kvs 4)	V5011E1213
	Actuator	LR230A(-S)	SSB31	ML6420A3015
Running time		90 sec.	150 sec.	60 sec.
FSV(#4046) setting		9	15	6

※ The table above is for your reference. It can be changed without advanced notice.

# 4. Installation

## Tank integrated hydro unit

4. Set the FSV value by referring to the table below depending on installation environment.

Function	Details	Code	Unit	Default	Min.	Max.
Mixing valve	Use or not	4041	-	0(No)	0	2
	Target temperature difference (Heating) (TW3-TW4)	4042	°C	10	5	15
	Target temperature difference (Cooling) (TW4-TW3)	4043	°C	10	5	15
	Control factor	4044	-	2	1	5
	Interval of valve control	4045	Min.	2	1	30
	Running time (10 second unit)	4046	(x10) sec	9	6	24

※ 4041 =1 : Controlled based on the temperature difference (4042, 4043)

※ 4041 =2 : Controlled based on the temperature difference of the WL value

ex) Heating

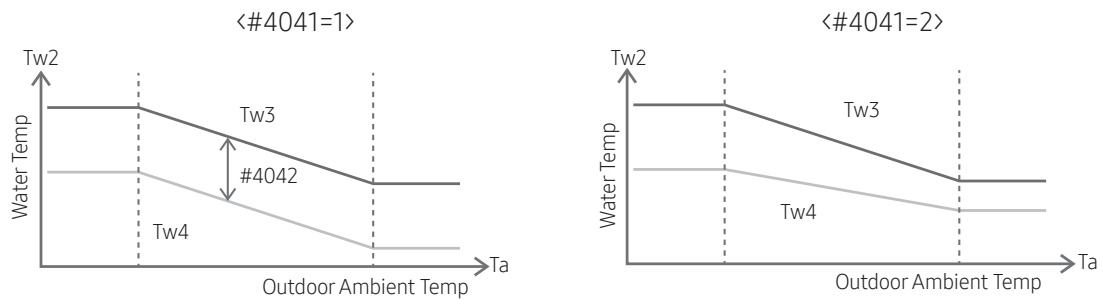

※ The mixing valve is controlled based on the FCU WL value.

※ As the #4044 value increases and the #4045 value decreases, the control speed increases. (Temperature hunting may occur if the control speed increases depending on the load.)

※ The additional pump and mixing valve should be purchased separately. TW4 sensor is included in the product accessories.

※ TW3 : Water temp. sensor 3

### **⚠ CAUTION**

- When the thermostat control is set as 'Use', the mixing valve can be used for Zone 1 and Zone 2. (When both FSV #2091 and #2092 are set as 1/2)
- When using Zone control (FSV 4061 = 1), ignore Thermostat signal.

# 4. Installation

## Tank integrated hydro unit

### 2-zone control using Thermostat

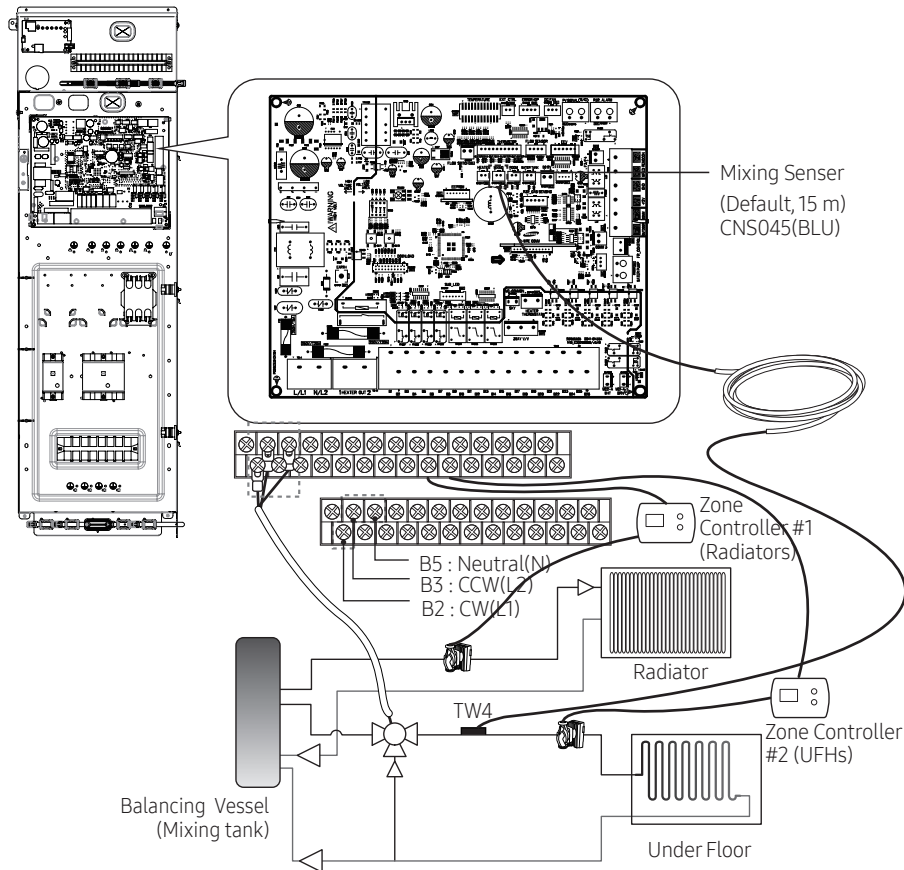

Description	No. of wires	Max. current	Thickness	Supply Scope
Mixing valve	4	22 mA	> 0.75 mm <sup>2</sup> , H05RN-F or H07RH-F	Field supply (230 V~, Input)

1. Before the installation, hydro unit should be turned off.
2. Using the appropriate equipment to correct position of terminal block as shown on the diagram.

# 4. Installation

## Tank integrated hydro unit

### 2-Zone Control Using Remote Controller

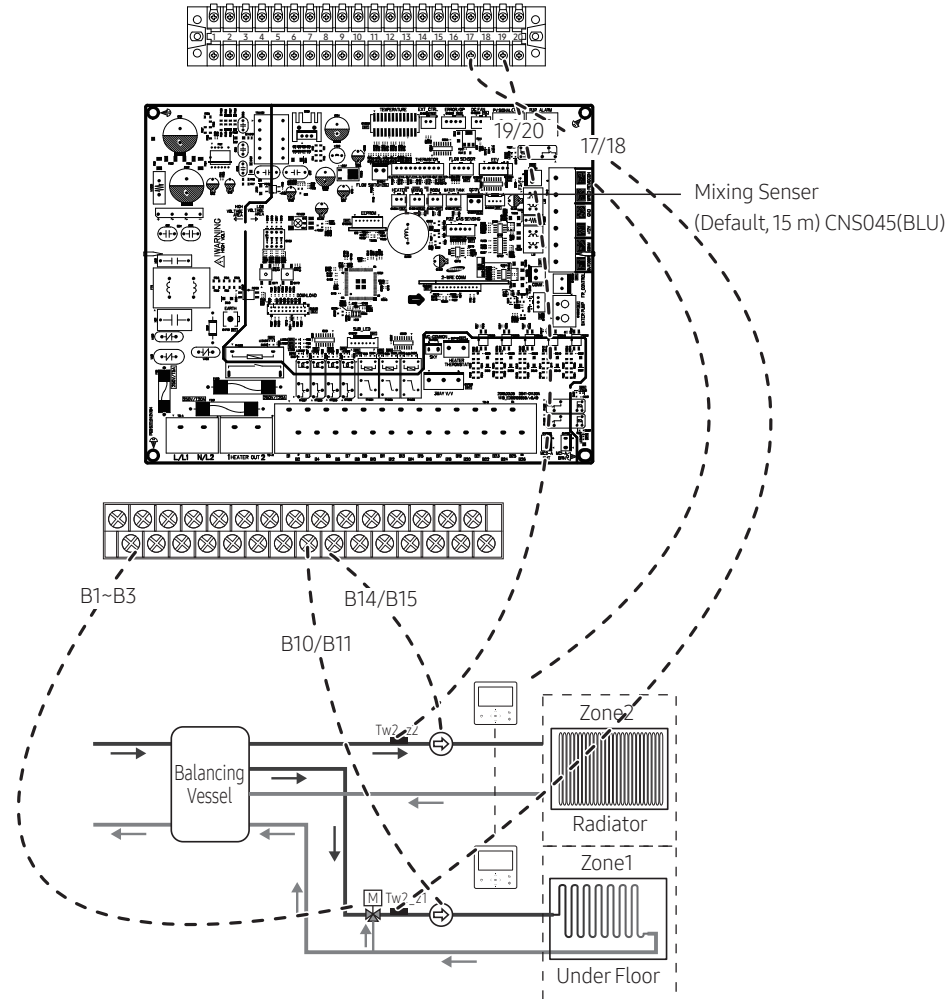

You can operate the 2-zone control using a mixing value, water-out temperature sensors, and built-in or external room temperature sensors installed in a wired remote controller.

When both zones are simultaneously Thermo on, the operation is performed based on Zone2. Therefore, set the zone that you want to have the higher set temperature to Zone2.

(The mixing valve must be installed in the zone that you want to have the lower set temperature.)

1. Install the mixing valve. (See "Installation of mixing valve.")
  2. Install the water-out temperature sensors (Tw2\_z1, Tw2\_z2) for all zones.
  3. Unlike the zone control with a thermostat, connect the water pump signal lines to the product.
    - Zone1 water pump connection: B10 (L1) + B11 (N)
    - Zone2 water pump connection: B14 (L1) + B15 (N)
  4. FSV 4061 = 1: Enable the 2-zone control using the wired remote controller.
- ※ If you want to operate the 2-zone control by using water-out temperatures, you have only to complete steps 1 to 4 above.
- ※ If you want to operate the 2-zone control by using room temperatures and built-in temperature sensors in wired remote controllers, you must install two wired remote controllers in each room. (If you use external room temperature sensors, you can control each room temperature with only one wired remote controller.)
- ※ In case you want more information about the controllers and accessories, please refer to the Controller and Accessory TDB on [pvi.Samsung.com](http://pvi.Samsung.com) site or Global Partner Portal site.

# 4. Installation

## Tank integrated hydro unit

### Wiring work

\* When you use inlet hole through the cabinet top positions for power/communication wires, please fix the wire by using mount tie of the cabinet right.

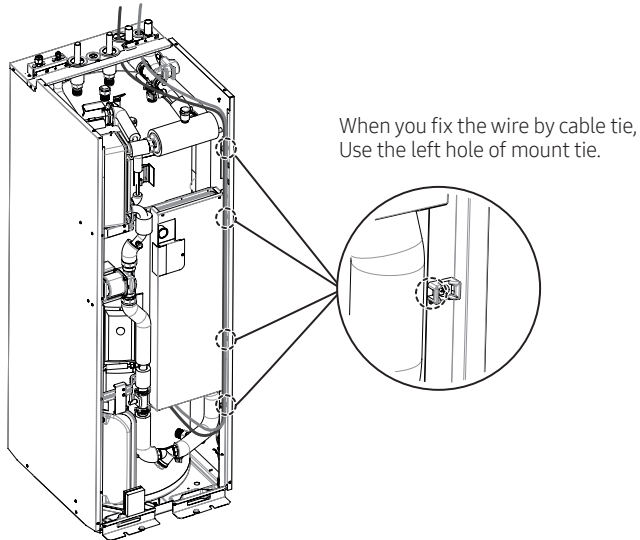

### 2 wires for communication cable

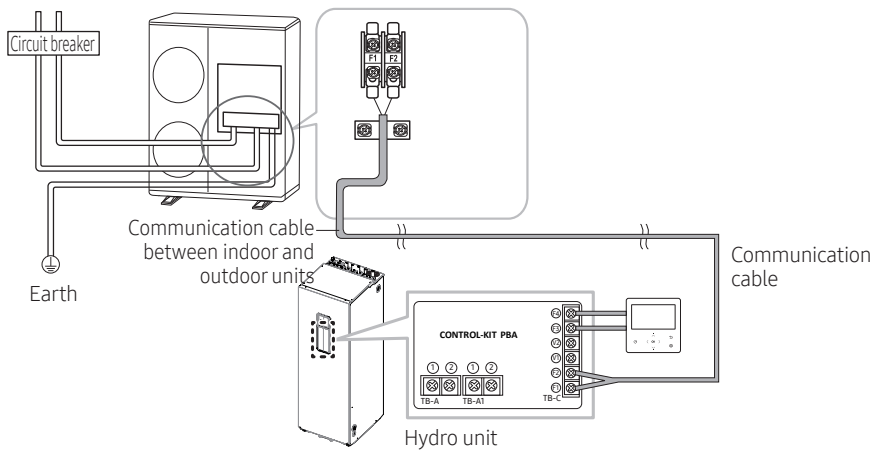

### Communication cable connection

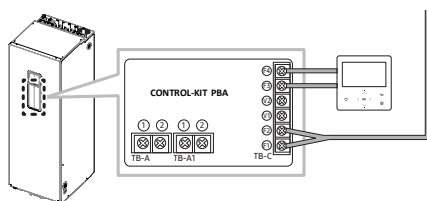

# 4. Installation

## Tank integrated hydro unit

### 1. 1 phase product

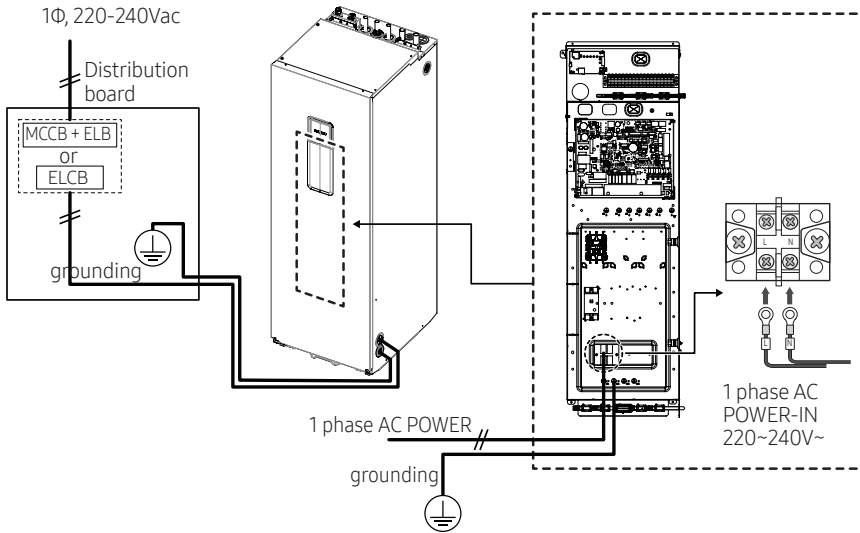

### 2. 3 phase product

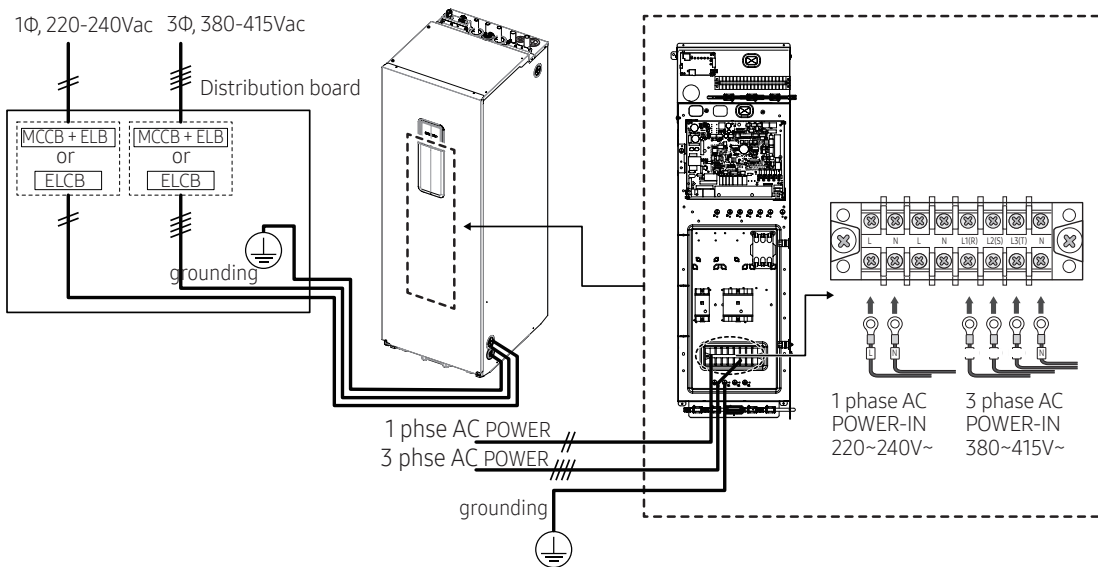

### ⚠ CAUTION

- If the supply cable is damaged, it must be replaced by a special cable or assembly available from the manufacturer or installer.
- Circuit Breaker (ELCB, ELB, MCCB etc.) for outdoor and indoor units shall be installed by installers because they are not sub-parts in the units. But you don't need to install for hydro unit (Built-in ELCB).
- It cause damage to chassis, PCB parts if the main power is not connected correctly. You should make certain that R, S, T is connected correctly before turning on the main power. (3 phase models only)

- ※ ELCB : Earth leakage circuit breaker
- ELB : Earth leakage breaker
- MCCB : Molded case circuit breaker



# 4. Installation

## Outdoor unit

### Space requirements for outdoor unit

#### When installing 1 outdoor unit

(Unit : mm)

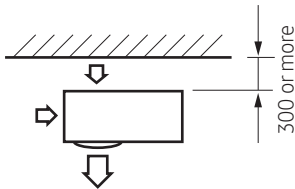

※ When the air outlet is opposite the wall

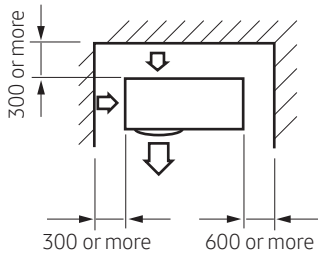

※ When 3 sides of the outdoor unit are blocked by the wall

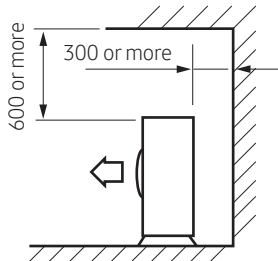

※ The upper part of the outdoor unit and the air outlet is opposite the wall

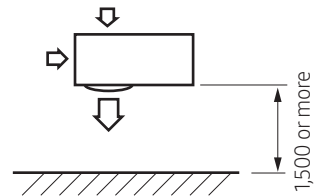

※ When the air outlet is towards the wall

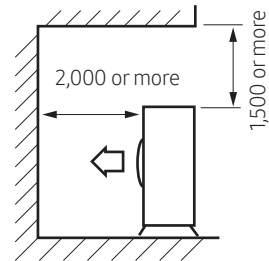

※ The upper part of the outdoor unit and the air outlet is towards the wall

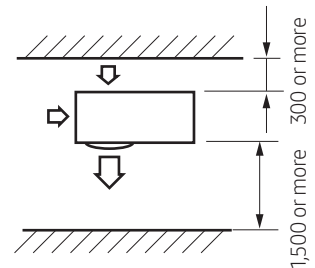

※ When front and rear side of the outdoor unit is towards the wall

# 4. Installation

## Outdoor unit

### When installing more than 1 outdoor unit

(Unit : mm)

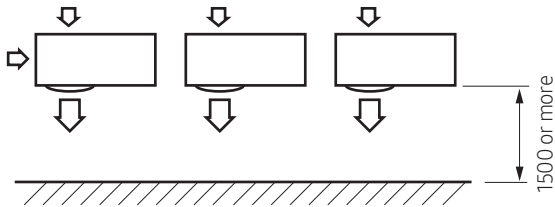

※ When the air outlet is towards the wall

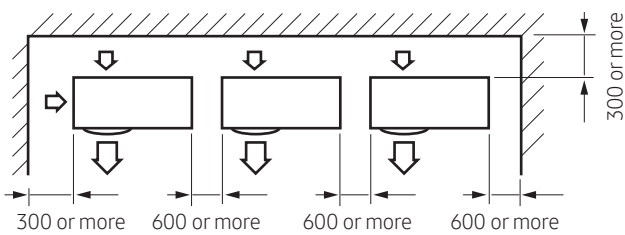

※ When 3 sides of the outdoor unit are blocked by the wall

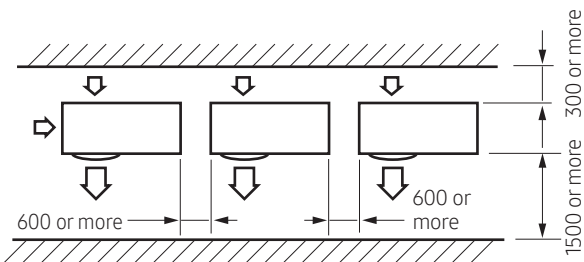

※ When front and rear side of the outdoor unit is towards the wall

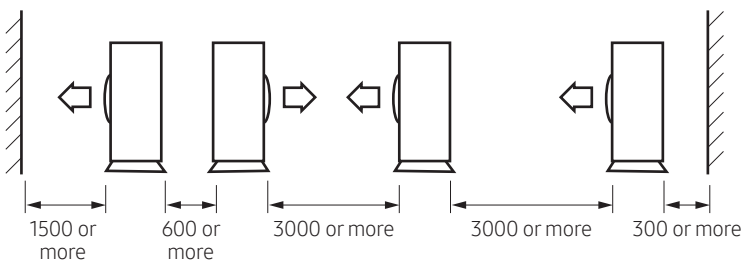

※ When front and rear side of the outdoor unit is towards the wall

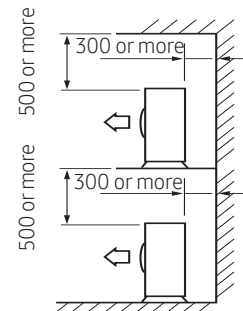

※ The upper part of the outdoor unit and the air outlet is opposite the wall

### ⚠ CAUTION

- The units must be installed according to distances declared, in order to permit accessibility from each side, either to guarantee correct operation of maintenance or repairing products. The unit's parts must be reachable and removable completely under safety condition (for people or things).

# 4. Installation

## Outdoor unit

### Outdoor unit installation

The outdoor unit must be installed on a rigid and stable base to avoid any increase in the noise level and vibration, particularly if the outdoor unit is to be installed in a location exposed to strong winds or at a height, the unit must be fixed to an appropriate support (wall or ground).

- Fix the outdoor unit with anchor bolts.

#### NOTE

- The anchor bolt must be 20mm or higher from the base surface.

#### CAUTION

- When tightening the anchor bolt, tighten the rubber washer to prevent the outdoor unit bolt connection part from corroding.
- Make a drain outlet around the base for outdoor unit drainage.
- If the outdoor unit is installed on the roof, you have to check the ceiling strength and waterproof the unit.

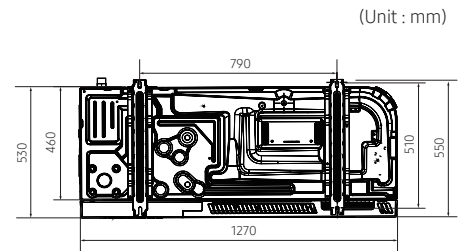

## Wiring

Two electronic cables must be connected to the outdoor unit.

- The connection cord between indoor unit and outdoor unit.
- The power cable between outdoor unit and auxiliary circuit breaker.
- Specially for Russian and European market, before installation, the supply authority should be consulted to determine the supply system impedance to ensure compliance.

#### CAUTION

- During the unit installation make first refrigerant connections and then electrical connections. If unit is uninstalled first disconnect electrical cables, then refrigerant connections.
- Connect the Air to water heat pump to grounding system before performing the electrical connection.
- When installing the unit, you shouldn't use inter connection wire.

## Example of EHS system

### When using ELB/ELCB for 1 phase (220-240V~)

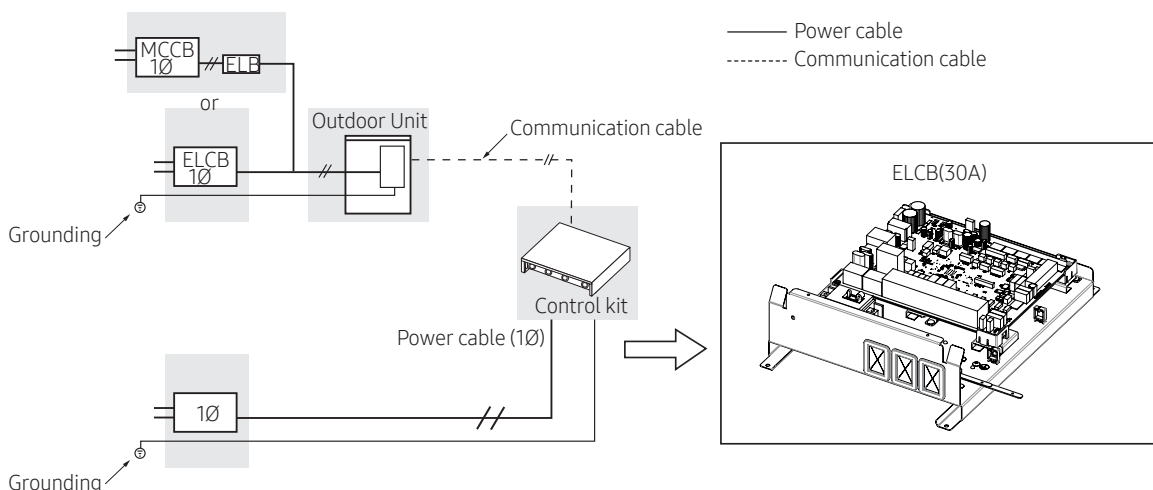

# 4. Installation

## Outdoor unit

### Example of EHS system

When using ELB/ELCB for 3 phase 4 wires (380-415V~)

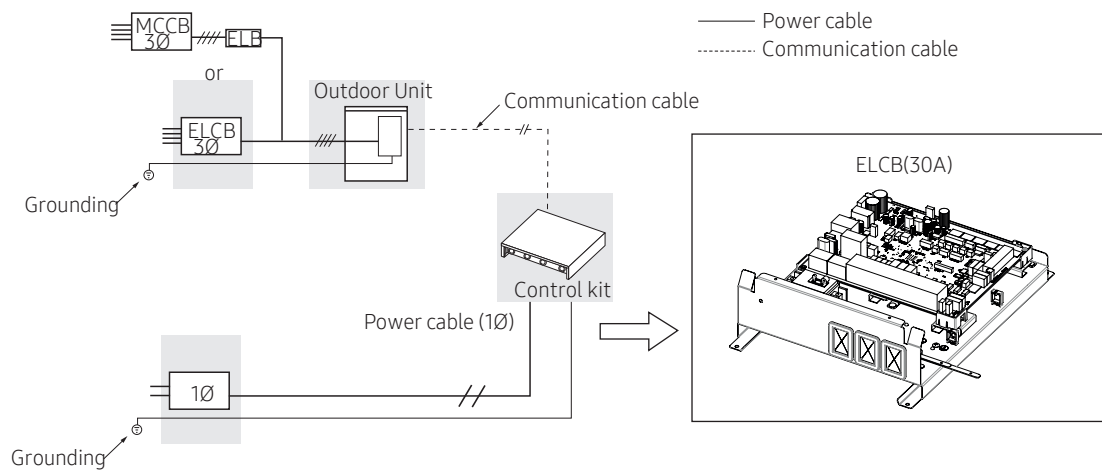

- For installing protection devices, please follow local electrical regulations (HD-IEC 60364).
- Installation of control kit must be followed its Installation manual.

# 4. Installation

## Outdoor unit

### Power Cable Specifications

#### 1 phase

Outdoor unit	Rated		Voltage Range		MCA	MFA
	Hz	Volts	Min	Max	Min. Circuit Amps.	Max. Fuse Amps.
AE080BXYDEG	50	220-240	198	264	26 A	28.6 A
AE120BXYDEG	50	220-240	198	264	32 A	35.2 A
AE140BXYDEG	50	220-240	198	264	32 A	35.2 A

- The power cable is not supplied with Air to water heat pump .
- Supply cords of parts of appliances for outdoor use shall not be lighter than polychloroprene sheathed flexible cord (Code designation IEC:60245 IEC 57 / CENELEC:H05RN-F)
- This Equipment complies with IEC 61000-3-12 .

Indoor Unit	Load	Power supply	Power cable	MAX. length	Type GL 
			mm <sup>2</sup> ,wires	m	A
MIM-E03CN MIM-E03EN	No Heater (Water Pump, Valve, Wired RMC)	1Ø, 220-240V, 50Hz	1.5 / 3	<10m	10
			2.5 / 3	10m<L<20m	10
	Booster Heater (3kw)		4.0 / 3	<10m	20
			6.0 / 3	10m<L<20m	20
			Booster Heater (~3kw) + Backup Heater (~3kw)	6.0 / 3	<10m
8.0 / 3	10m<L<20m	40			

- The Power cable is not supplied with the heat pump .
- For power cable, use the grade H05RN-F materials in 1Ø system .
- If you connect Backup Heater at separated power cable, you can reduce wire size . (Please refer to control kit installation manual)

#### 3 Phase

Outdoor unit	Rated		Voltage Range		MCA	MFA
	Hz	Volts	Min	Max	Min. Circuit Amps.	Max. Fuse Amps.
AE080BXYDGG	50	380-415	342	457	16.1 A	17.7 A
AE120BXYDGG	50	380-415	342	457	16.1 A	17.7 A
AE140BXYDGG	50	380-415	342	457	16.1 A	17.7 A

- The power cable is not supplied with air to water heat pump .
- Supply cords of parts of appliances for outdoor use shall not be lighter than polychloroprene sheathed flexible cord (Code designation IEC:60245 IEC 66 / CENELEC:H07RN-F)
- This equipment complies with IEC 61000-3-12 provided that the short-circuit power Ssc is greater than or equal to 3.3[MVA] at the interface point between the user's supply and the public system . It is the responsibility of the installer or user of the equipment to ensure, by consultation with distribution network operator if necessary, that the equipment is connected only to a supply with a short-circuit power Ssc greater than or equal to 3.3[MVA] .

# 4. Installation

## Outdoor unit

### Wiring diagram of power cable

#### When using ELB for 1 phase and 3 phase

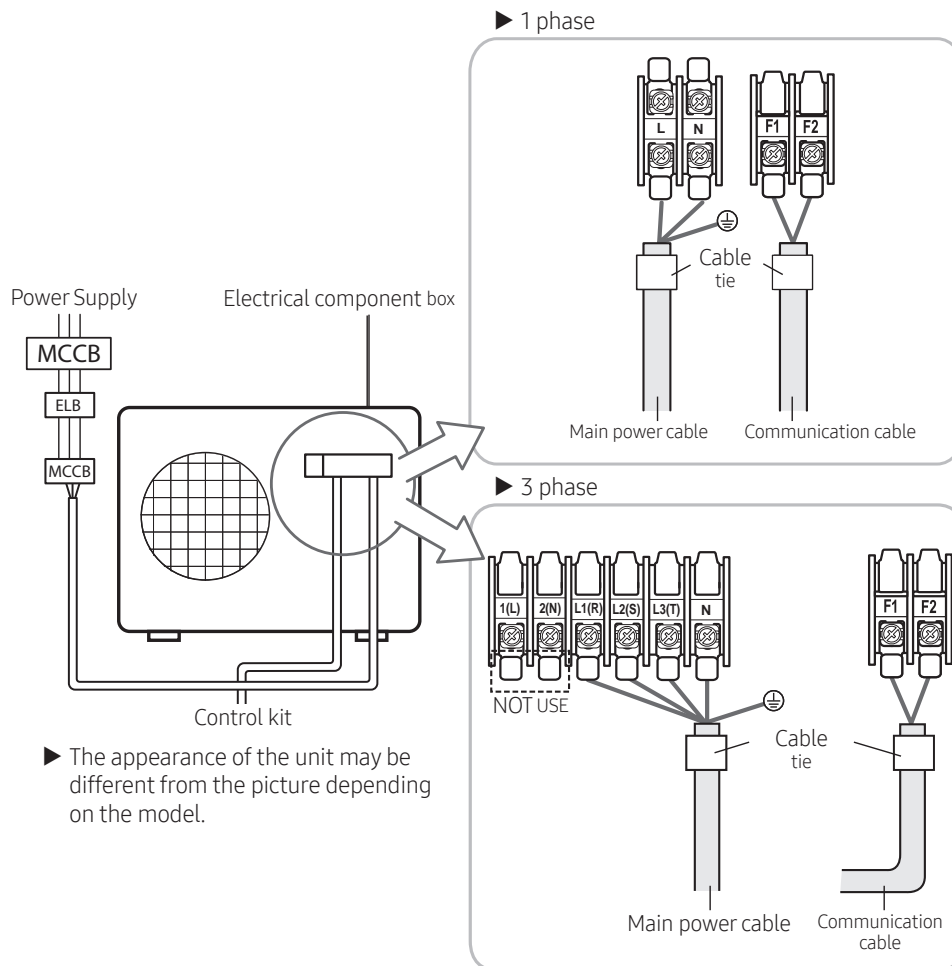

### CAUTION

- You should connect the power cable into the power cable terminal and fasten it with a clamp.
- The unbalanced power must be maintained within 2% of supply rating.
  - If the power is unbalanced greatly, it may shorten the life of the condenser. If the unbalanced power is exceeded over 4% of supply rating, the control kit is protected, stopped and the error mode indicates.
- To protect the product from water and possible shock, you should keep the power cable and the connection cord of the control kit and outdoor units within ducts. (with appropriate IP rating and material selection for your application)
- Ensure that main supply connection is made through a switch that disconnects all poles, with contact gap of a least 3 mm.
- Devices disconnected from the power supply should be completely disconnected in the condition of overvoltage category.
- Keep distances of 50mm or more between power cable and communication cable.

# 4. Installation

## Outdoor unit

### Wiring diagram of connection cord

#### 1 phase

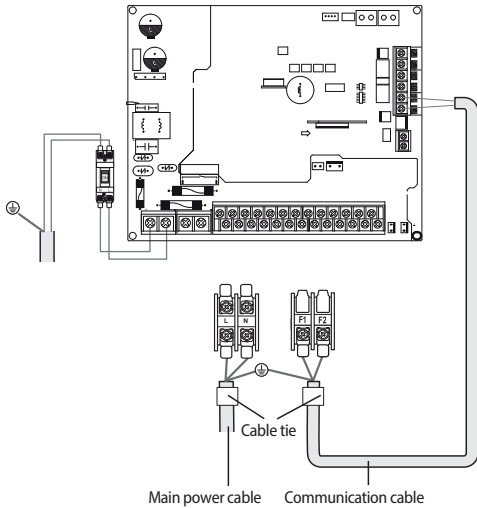

#### 3 phase

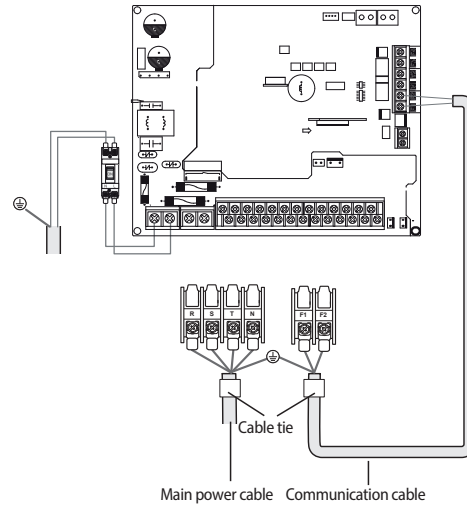

#### NOTE

- Lay the electrical wiring so that the front cover does not rise up when doing wiring work and attach the front cover securely.
- Ground wire for the indoor unit and outdoor unit connection cable must be clamped to a soft copper tin-plated eyelet terminal with screw hole (NOT SUPPLIED WITH UNIT ACCESSORIES).



### Freeze protection by glycol

Freeze protection solutions must use propylene glycol with a toxicity rating of Class 1 as listed in Clinical Toxicology of Commercial Products, 5th Edition.

**WARNING** • Ethylene glycol is toxic and must not be used in the primary water circuit in case of any cross-contamination of the potable circuit.

The required concentration of glycol depends on the lowest expected outdoor temperature, and on whether you want to protect the system from bursting or from freezing. To prevent the system from freezing, more glycol is required.

Add glycol according to the table below.

Freezing Points of Propylene Glycol - Water Mixtures		
Percent Propylene Glycol [wt. %]	Freezing Point [ °F ]	Freezing Point [ °C ]
0	32	0
10	26	-3
20	20	-7
30	10	-12
36	0	-18
40	-5	-20
43	-10	-23
48	-20	-29

2022. 09  
Ver.2.1

**Samsung Electronics Co., LTD.**

Head Office (Suwon Korea) 129, Samsung-Ro, Yeongtong-Gu, Suwon City, Gyeonggi-Do, Korea 16677  
Website : [www.samsung.com](http://www.samsung.com), <https://partnerhub.samsung.com> Email : [airconditioner@samsung.com](mailto:airconditioner@samsung.com)  
Images and data in this book may subject to change without prior notice.